

acaia



**Horizon
User Manual**

AHN101

Contents

3	In the Box
3	Introduction
3	Horizon Overview
4	Getting Started
4	Basic Operation
5	Using Your Horizon
5	Power On / Off
5	Depressurizing and Timer
6	How to Release
7	Configuration
7	How to Access and Navigate Settings
8	Settings Menu
9	Product Care Information
9	Charging Battery
9	Battery Status
9	Care and Cleaning
10	How to Replace the Silicone Ring
11	Firmware Update
12	Troubleshooting
13	Specifications

In the Box

Introduction

Thank you for choosing the Horizon. The Horizon is designed and manufactured to the most rigorous standards to provide you with the best sensory experience.

Start by checking your Horizon box to find the following items:

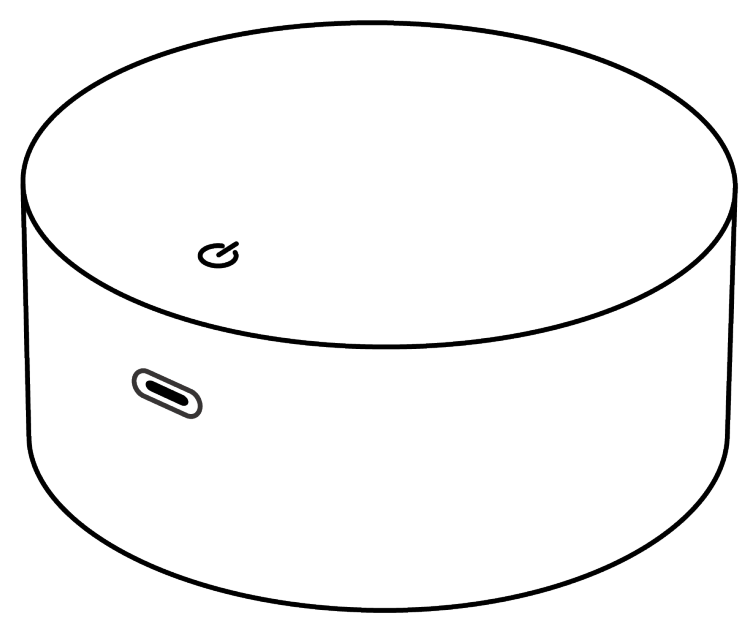

Acaia Horizon

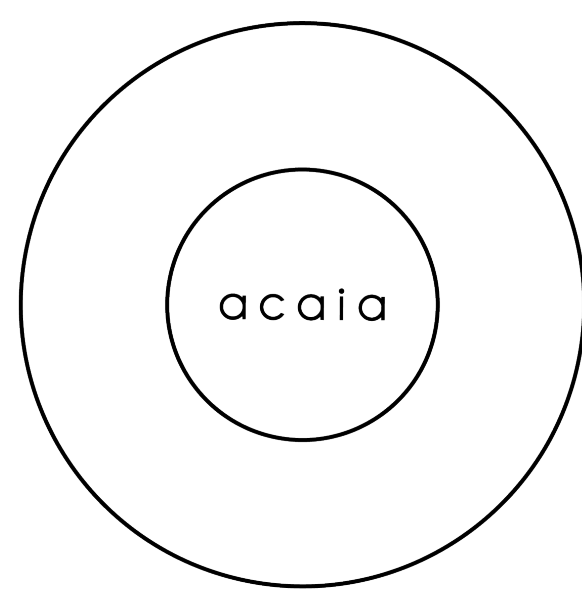

Silicone Drip Mat

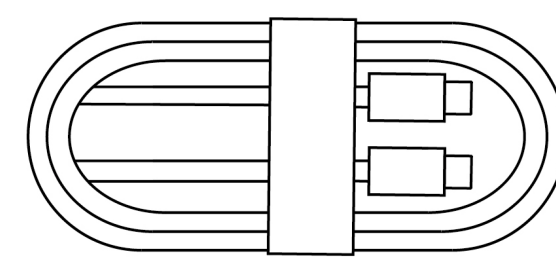

**USB-C
Charging Cable**

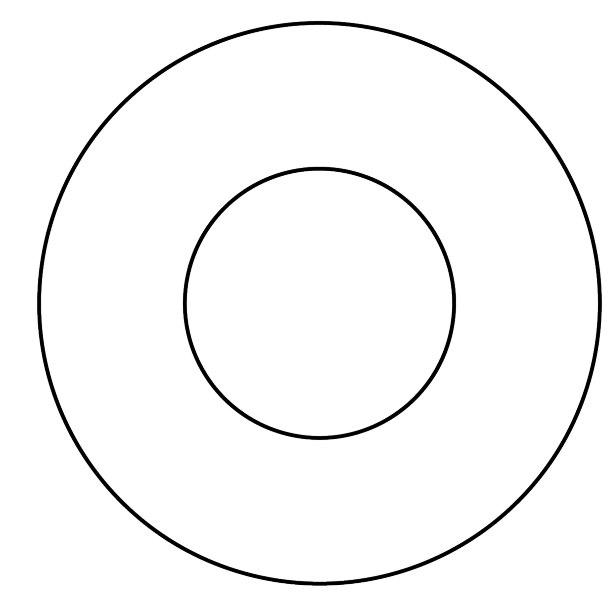

**Replacement
Silicone Ring**

Next, follow the instructions in **Getting Started** to begin using your Horizon. To take full advantage of the Horizon's many features, carefully read through this manual, which contains step-by-step procedures, examples, and other information.

Important: A protective film is applied to the top surface to prevent scratches. **Do not remove this film.**

Warning: Incorrect handling of this product could result in personal injury or physical damage.

Horizon Overview

Power

- Power On
- Power Off

Depressurizing

- Depressurize
- Release Pressure

Settings Menu

- Access Settings Menu*
- Toggle Options
- Select/Confirm Option

*while powered off

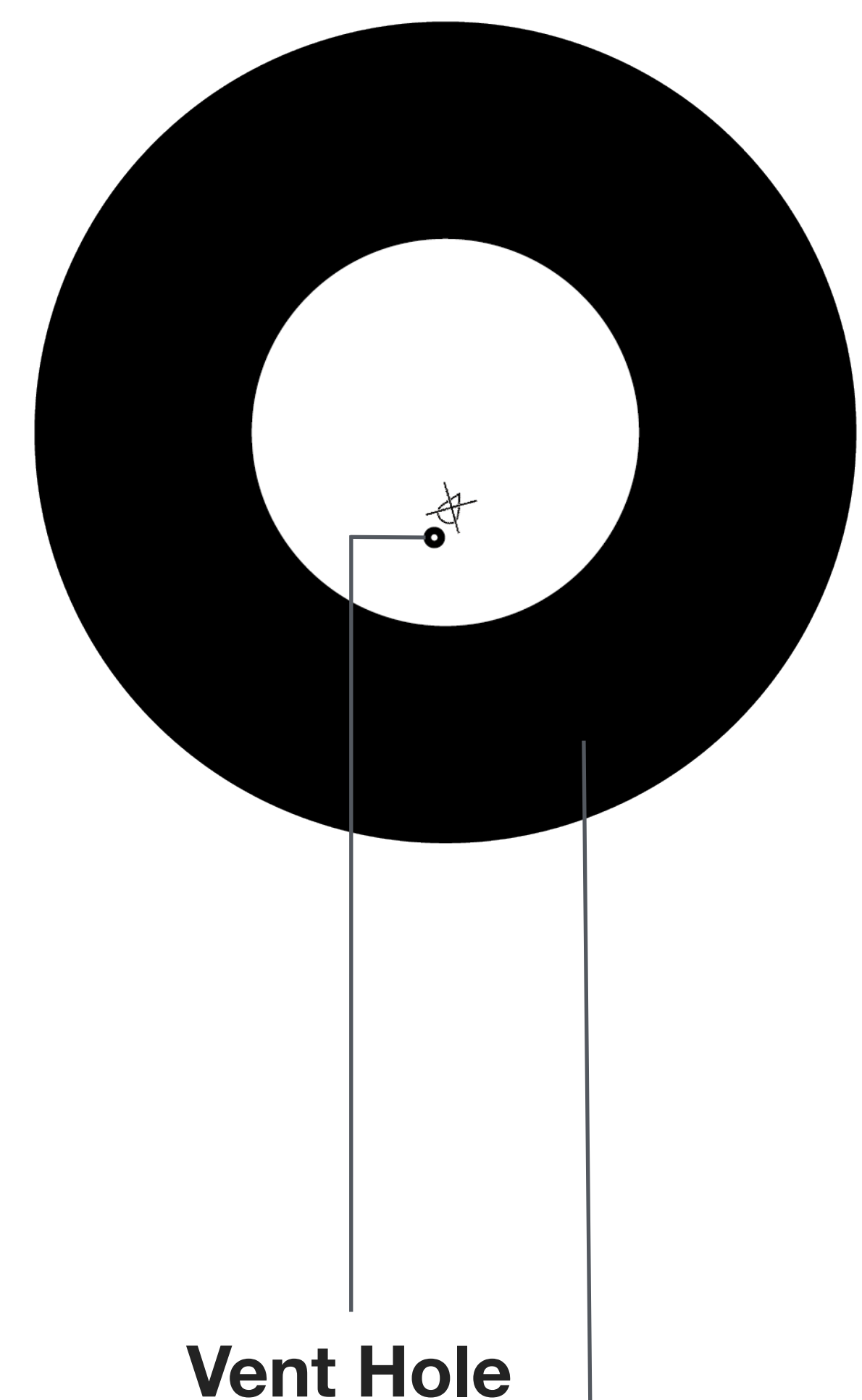
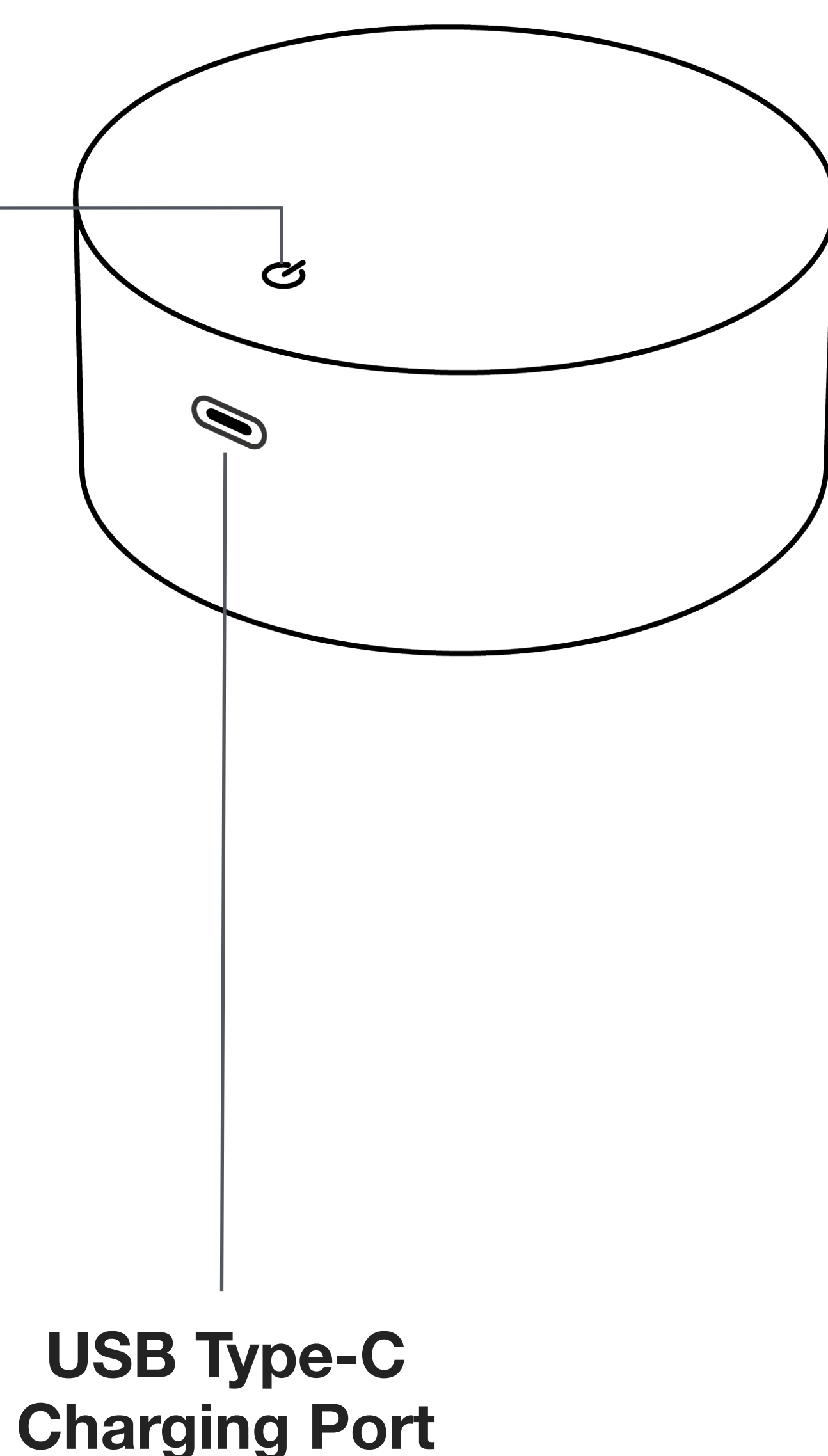

Silicone Ring

Inner diameter: 40 mm
Outer diameter: 85 mm

- Tap
- Press and Hold

Getting Started

Basic Operation

 [Learn more](#)

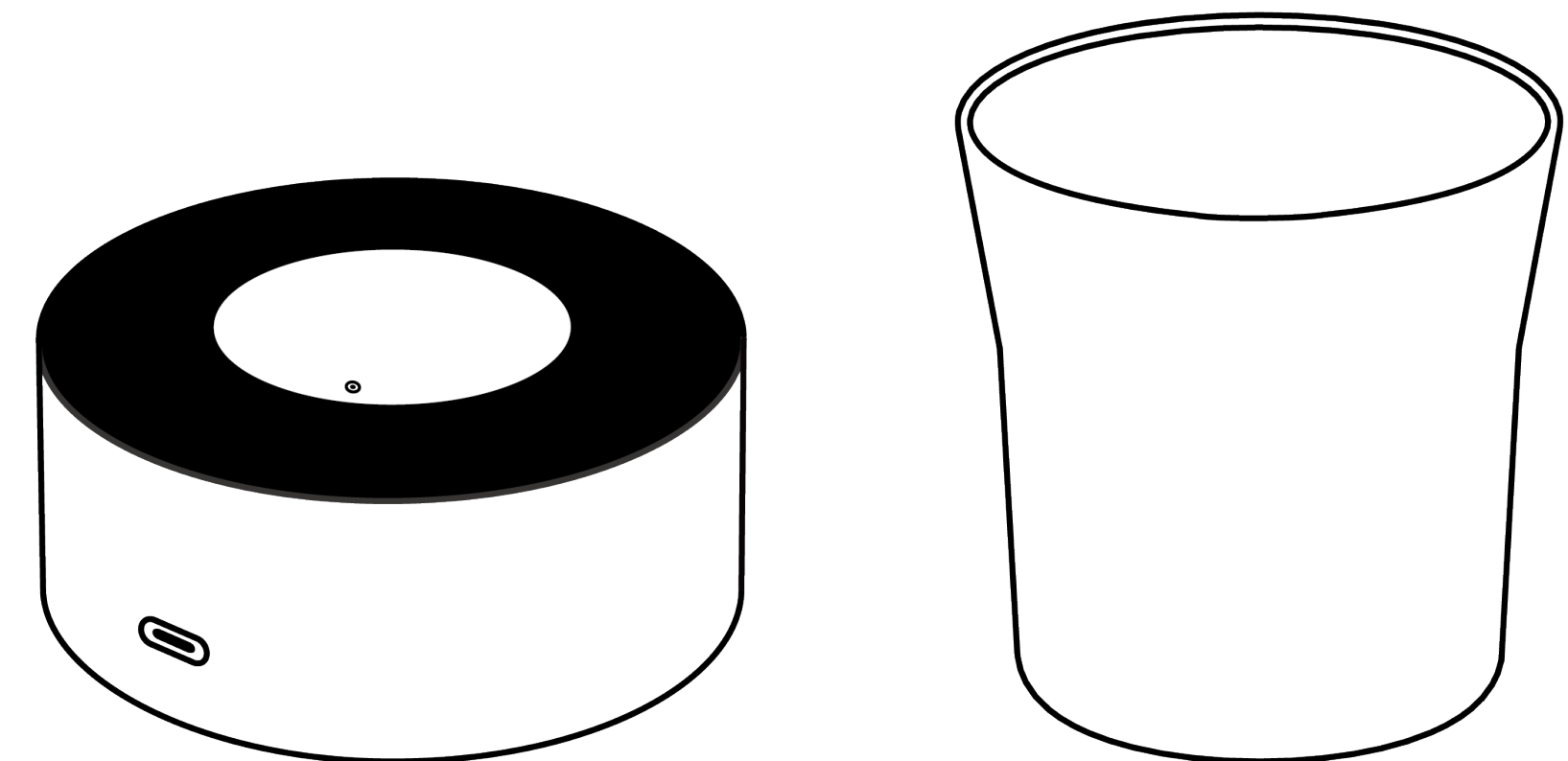
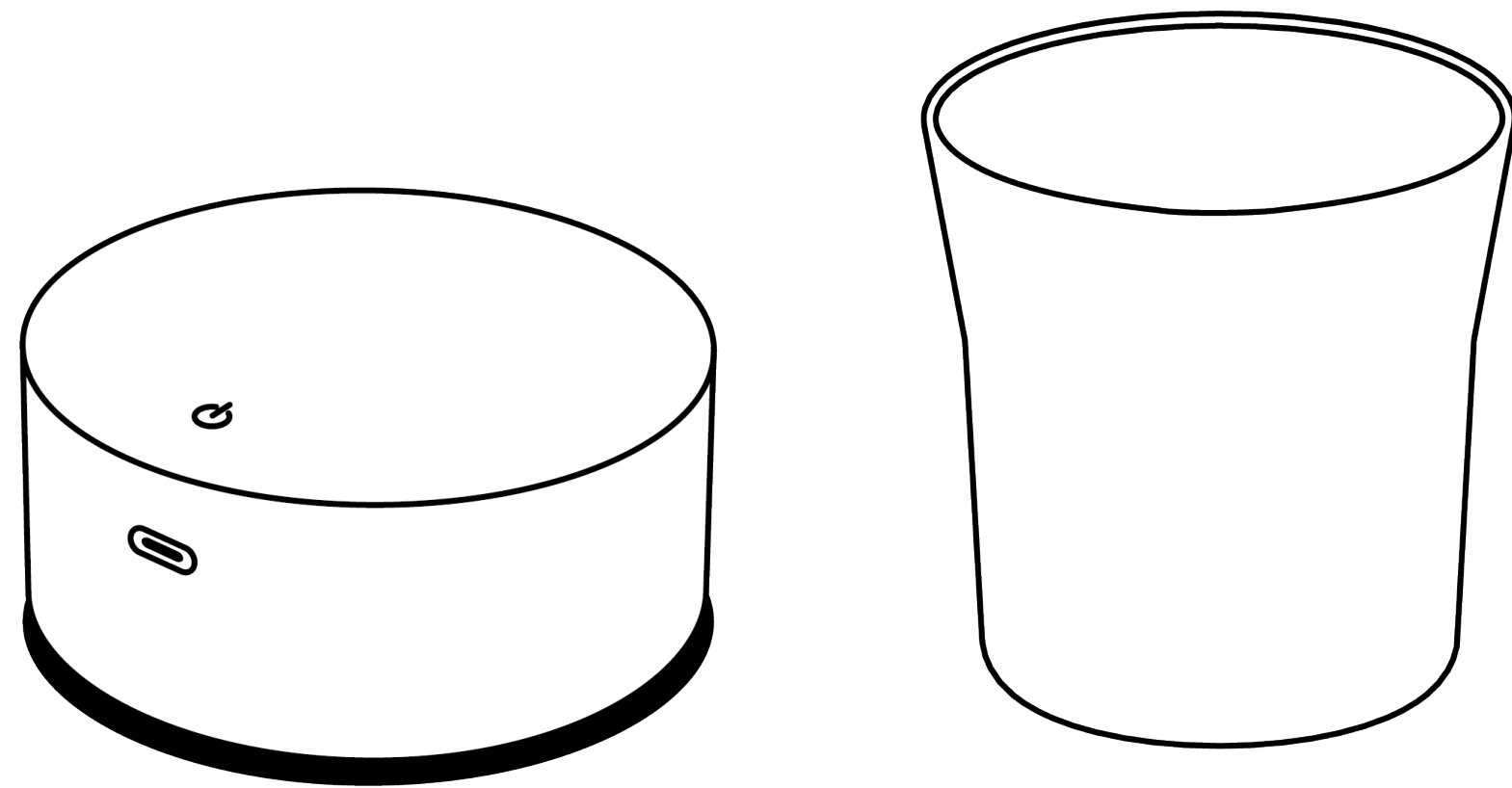

1. Place the Horizon on a level, stable, and vibration-free surface.

2. Select a cup that meets the requirements in the note below for optimal depressurization.

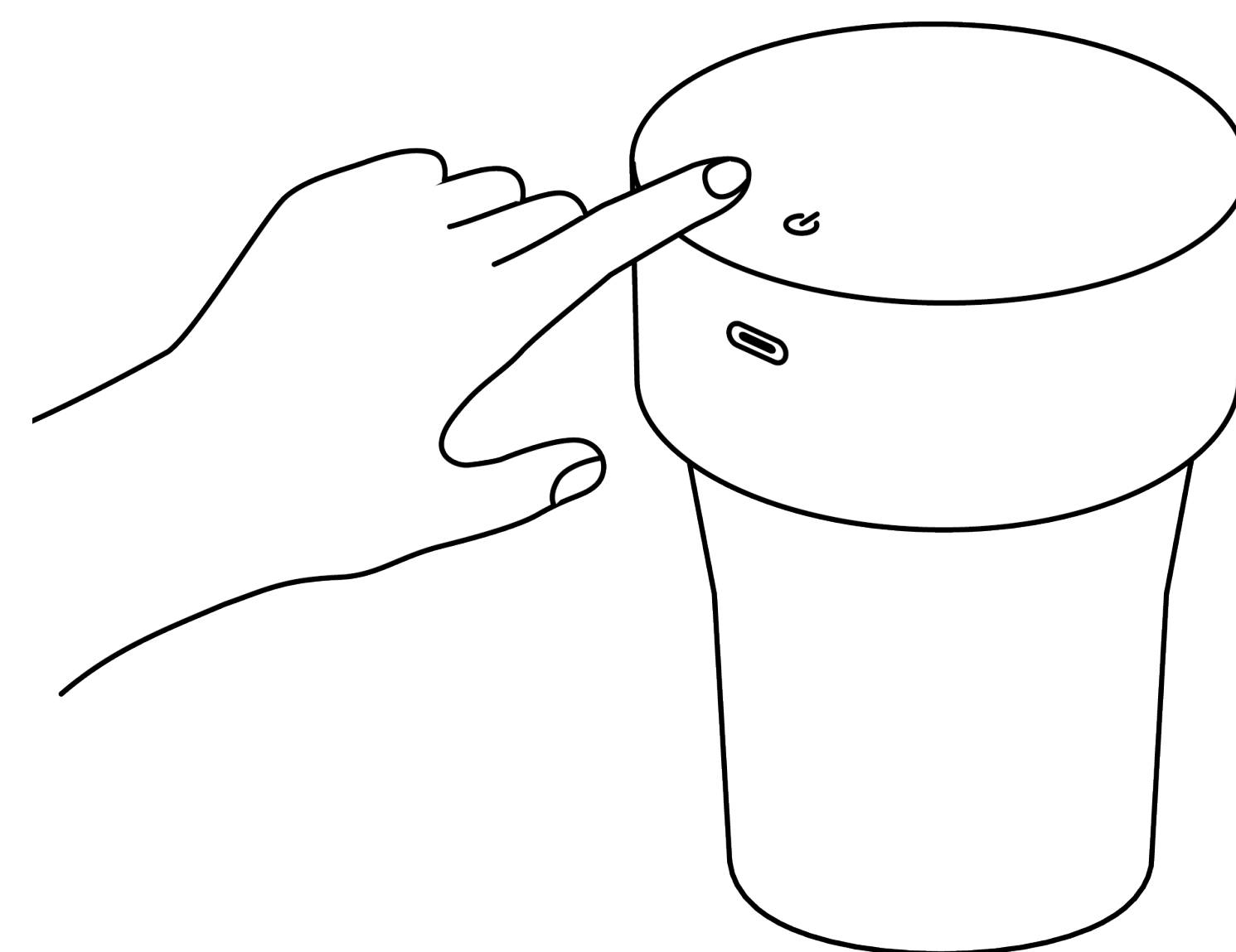
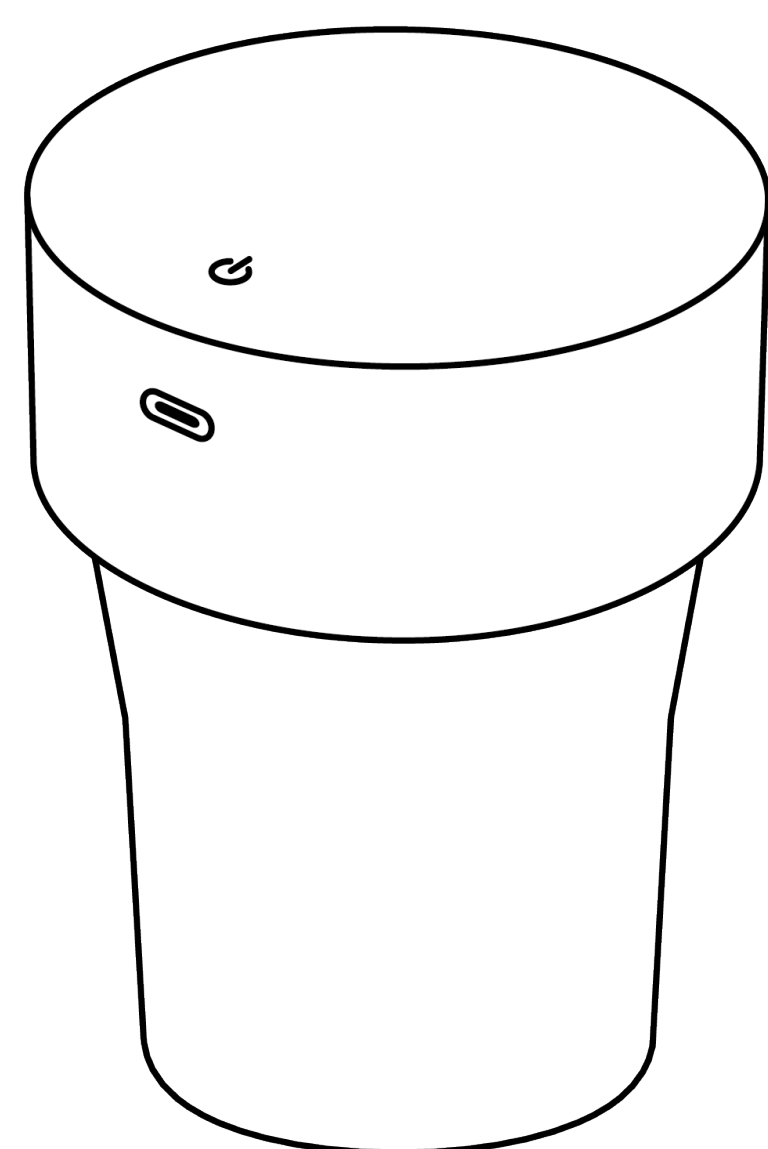

3. Place the Horizon on top of the cup. Ensure the silicone ring is centered and flush with the cup rim to create a proper seal.

4. Power on to start. To adjust settings before first use, please see **Configuration**.

Note:

- **Recommended Cup Rim Inner Diameter:** 45 mm – 80 mm
- **Requirement:** Use a rigid cup with a stable, continuous rim (**no spouts, openings or indentations**) to ensure a proper seal. If the cup rim is uneven, press down gently on the Horizon while depressurizing to facilitate the seal until the screen displays "COMPLETE".

Using Your Horizon

Power On / Off

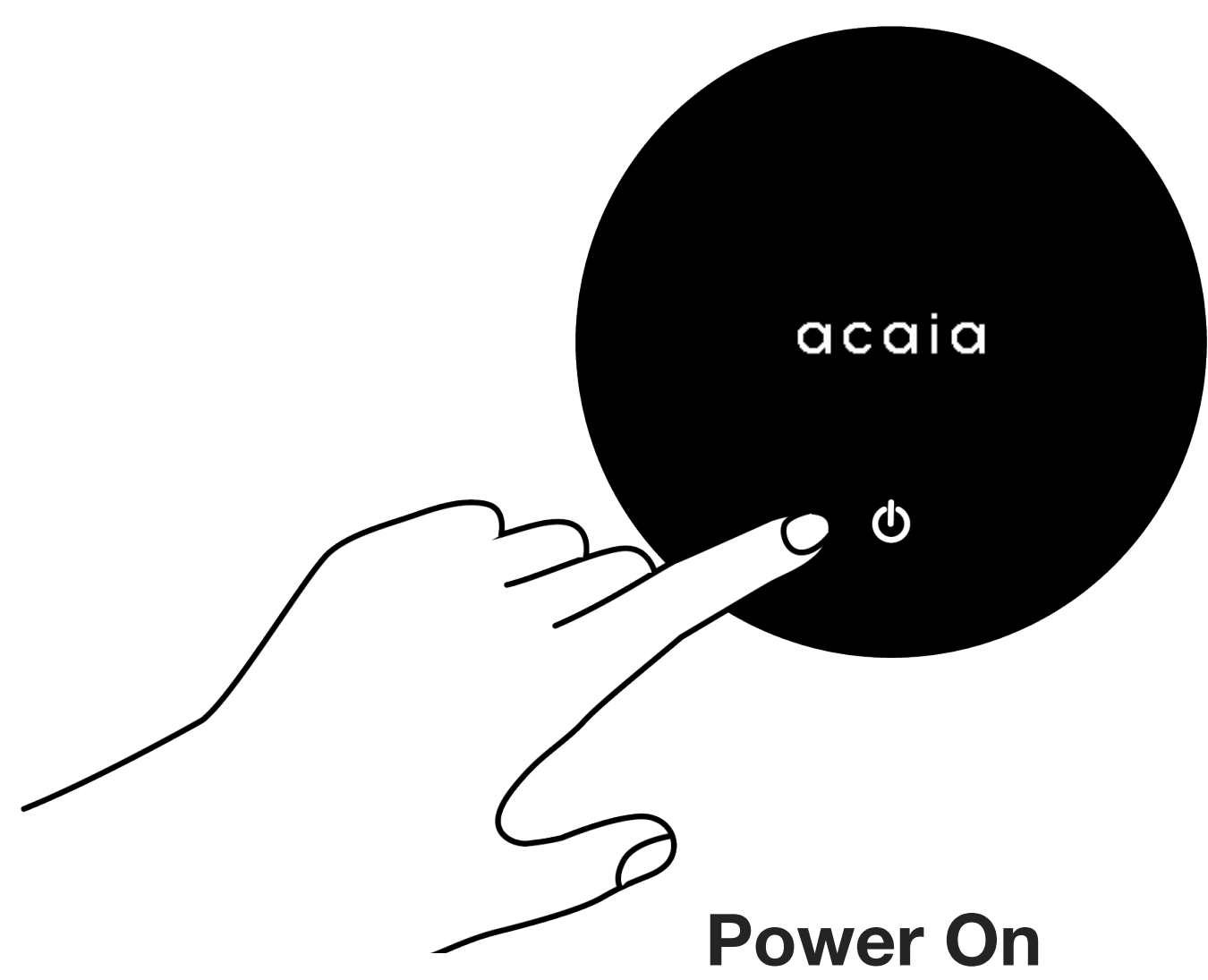

Tap the **Power** button once.

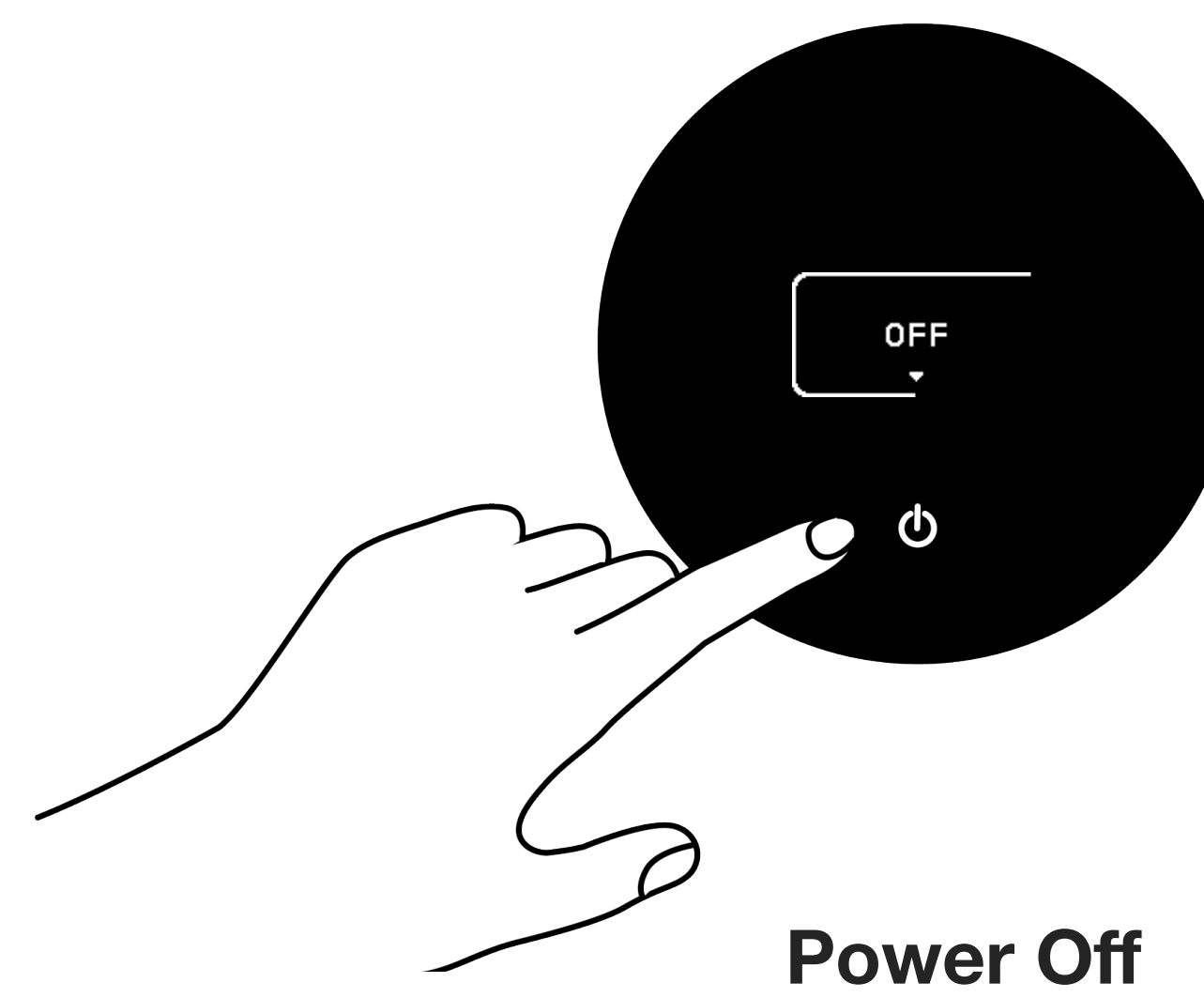

Press and hold the **Power** button until the screen displays "**OFF**" and a full frame forms around the text.

Depressurizing and Timer

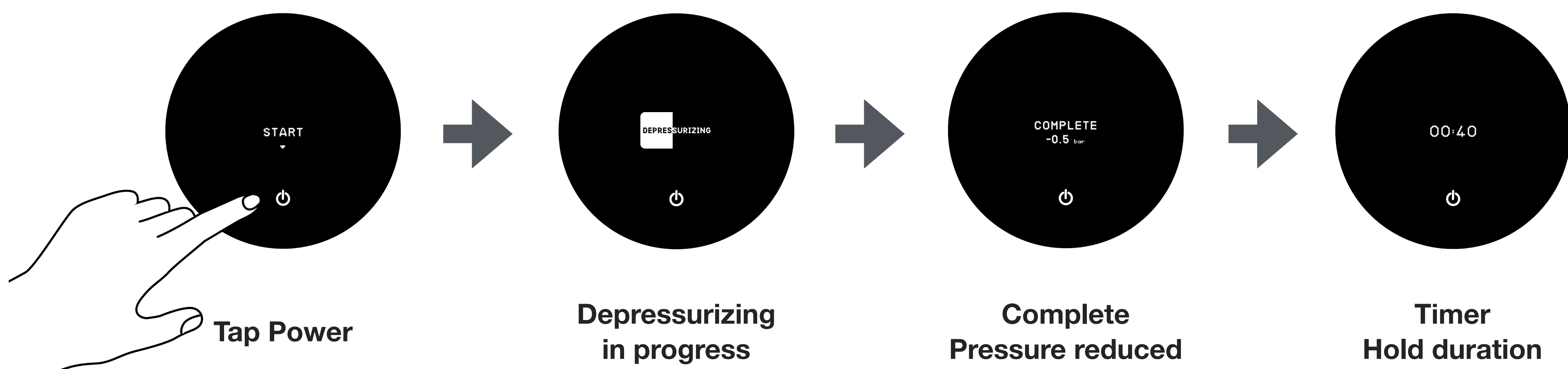

On the **Start** screen, tap the **Power** button once to start depressurizing. The screen will display "**DEPRESSURIZING**" inside a progress bar.

When finished, the screen will display "**COMPLETE**" and the amount of pressure reduced, then enter the **Timer** screen.

Note: The time displayed on screen represents **how long low pressure is maintained**, excluding the initial depressurization phase.

How to Release

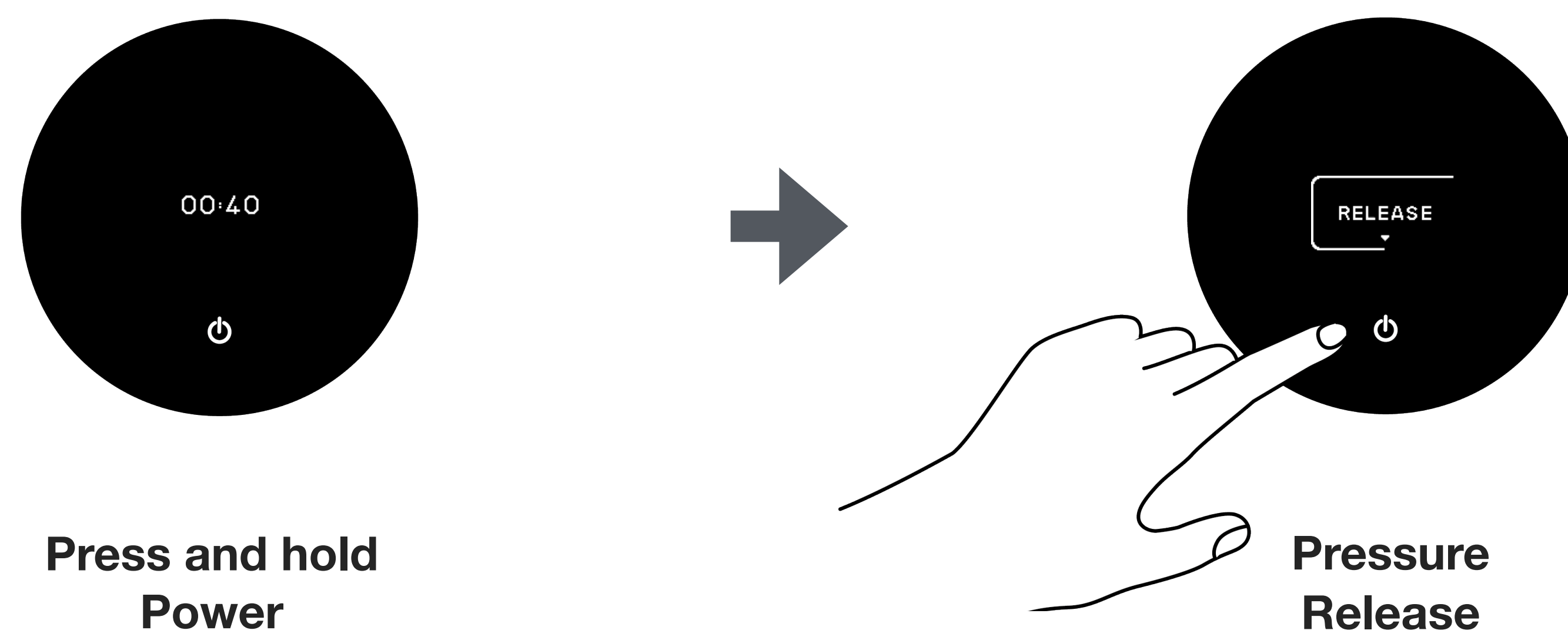

On the **Timer** screen, press and hold the **Power** button until the screen displays "**RELEASE**" and a full frame forms around the text.

The process is complete when you hear the sound of air being released. Hold the cup down while removing the Horizon, as it may slightly stick to the cup rim even after the air is released.

Note: Plugging in the power cable while on the **Timer** screen will automatically trigger a release.

Configuration

How to Access and Navigate Settings

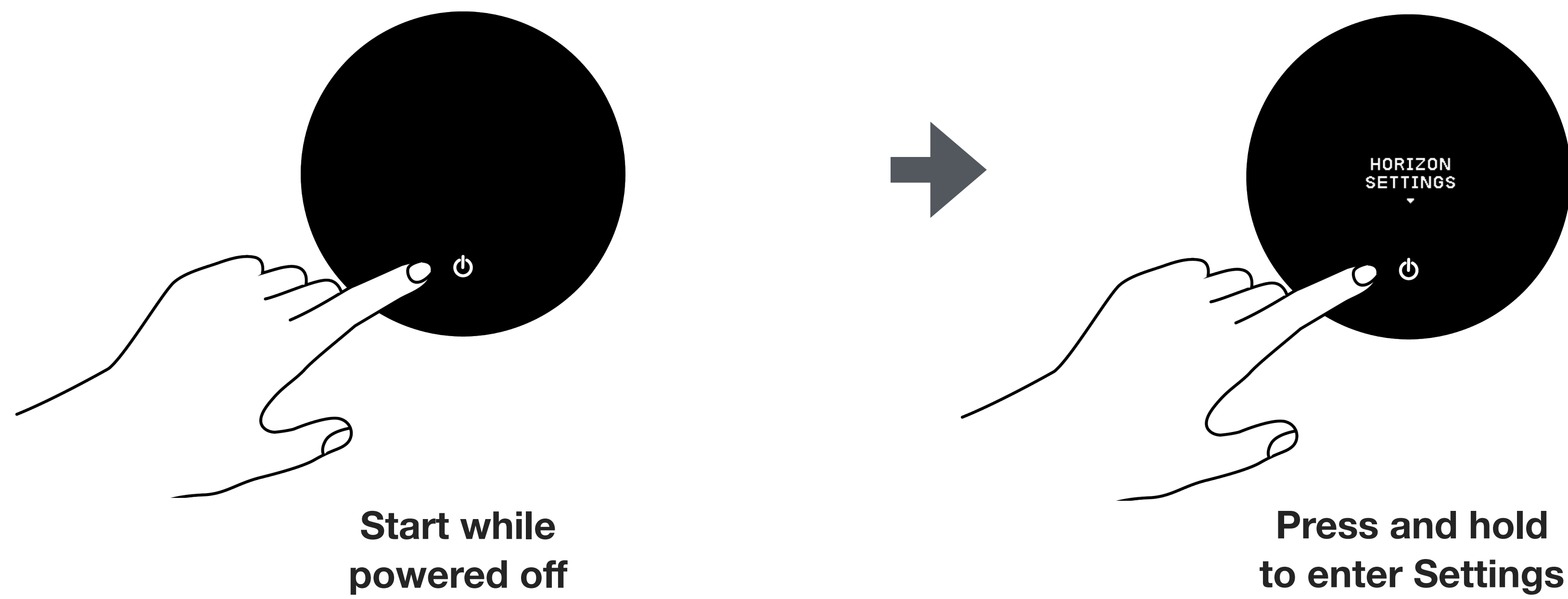

To enter Settings, make sure the Horizon is powered off. Press and hold the Power button until "**HORIZON SETTINGS**" appears, then press and hold until a full frame forms around the text.

Please refer to the table below to navigate the settings menu.

Action	Operation
Next Setting	Tap Power button
Enter Setting	Press and hold Power button
Toggle Options	Tap Power button
Confirm Option	Press and hold Power button
Exit Settings	Find "EXIT" in the Settings menu, then press and hold the Power button

Settings Menu

Setting	Display	Options	Default
Target Pressure Setting	STRENGTH	STRONG, GENTLE	STRONG
Auto-Release Setting	AUTO RELEASE	OFF, 30 SEC, 45 SEC, 60 SEC, 75 SEC, 90 SEC, 120 SEC	OFF
Auto-Off Setting	AUTO OFF	5 MIN, 10 MIN, OFF	5 MIN
Exit	EXIT	-	-
Reset to Default	RESET TO DEFAULT	YES, NO	NO
About Device	ABOUT	BAT, FW	-

Target Pressure Setting

The default setting is **STRONG**.

You can adjust the depressurization strength to achieve different atmospheric pressure levels.

- STRONG: pressure reduced by ~0.5 bar
- GENTLE: pressure reduced by ~0.3 bar

Auto-Release Setting

The default setting is **OFF**.

You can select how long the low-pressure state is maintained before pressure is released automatically.

The selected time is displayed below the Timer as a reference.

You can still manually release at any time by pressing and holding the Power button.

Auto-Off Setting

The default setting is **5 MIN**.

You can select the amount of time after which the Horizon powers off due to inactivity, or disable this feature.

Exit

Exit the Settings menu and go to the Start screen.

Reset to Default

Select **YES** to restore all settings to factory defaults.

About Device

The current battery level is displayed at the top (**BAT**), and the current firmware version is displayed at the bottom (**FW**).

Product Care Information

Charging Battery

You can charge the battery by plugging the USB-C cable into any of the power sources listed below:

- A computer
- A USB-C wall charger with an output of 5 V / 1 A
- A USB-C PD charger supporting 5 V

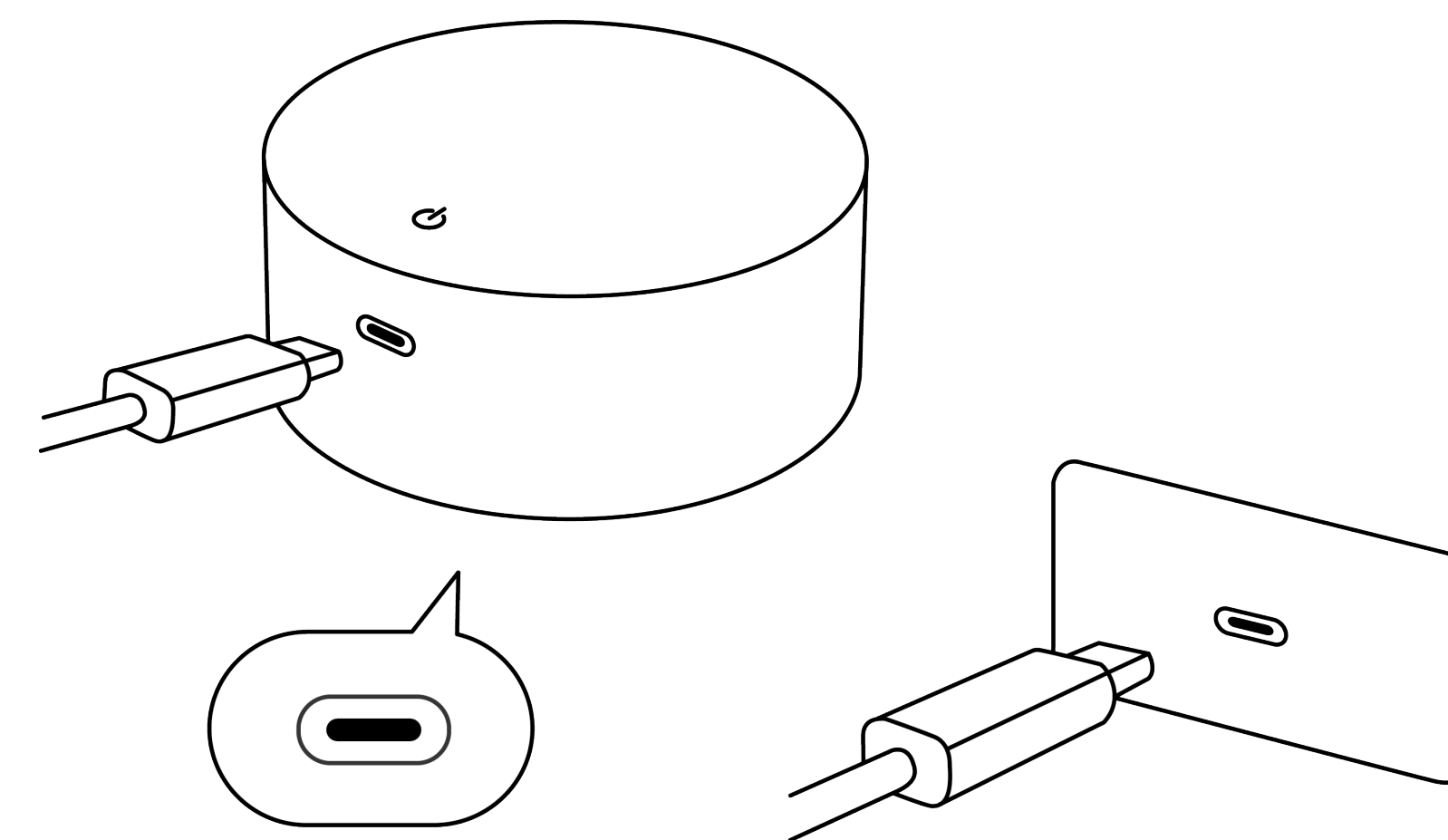

Use only certified USB-C chargers with appropriate voltage output to ensure safe operation.

It takes about 1 to 2 hours to fully charge the battery. To avoid depressurization issues, please avoid letting the battery drain completely before charging; charge at any time as needed.

Note: To increase stability during use, avoid using the device while it is charging.

Battery and Charging Status



Battery Status

You can find "ABOUT" in Settings to check the battery level (BAT) at any time.



Sufficient Power

Battery icon is hidden.



Low Battery Warning (one bar remaining)

A battery icon is shown above START with one bar, and "LOW BATTERY" is shown briefly during depressurization. Please connect the charger immediately to prevent the device from powering off during use.



Charging

The battery icon is shown with a lightning bolt.



Charging Complete

The battery icon is shown with full bars.

Care and Cleaning

- Use a soft cloth with warm water only to clean the product.
- Do not use detergent, solvents, or other chemicals, as they may damage the anodized surface. Do not rinse or immerse the product in water.
- After use, gently pat dry with a clean cloth or paper towel to prevent moisture from entering the vent hole and affecting performance.
- Always place the Horizon on the silicone drip mat after use to keep your workspace dry.

How to Replace the Silicone Ring

When to Replace

Replace the silicone ring if it appears stretched, torn, or deformed, or if the Horizon repeatedly displays "**DEPRESSURIZE ERROR**" even when the cup is properly positioned. A worn ring cannot maintain a proper seal and will affect depressurization performance.

How to Replace

Follow the steps below to replace the silicone ring on your Horizon.

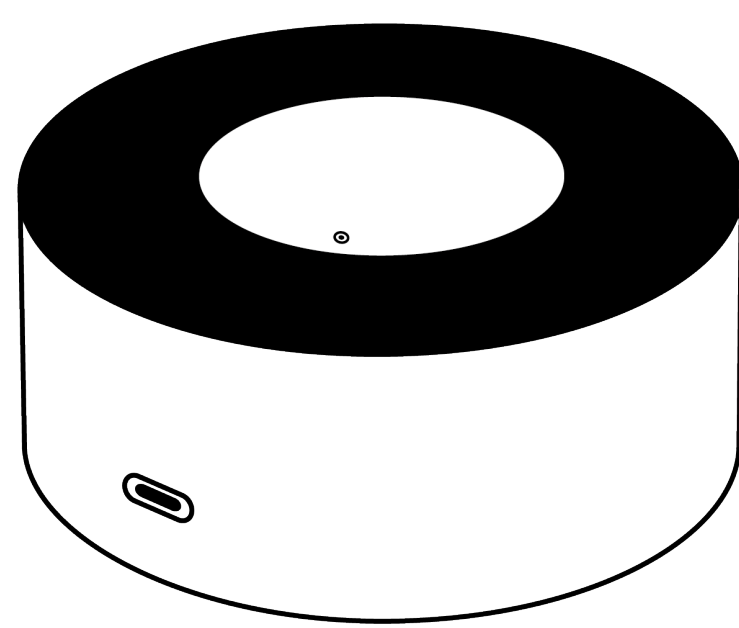

Turn the Horizon upside down.

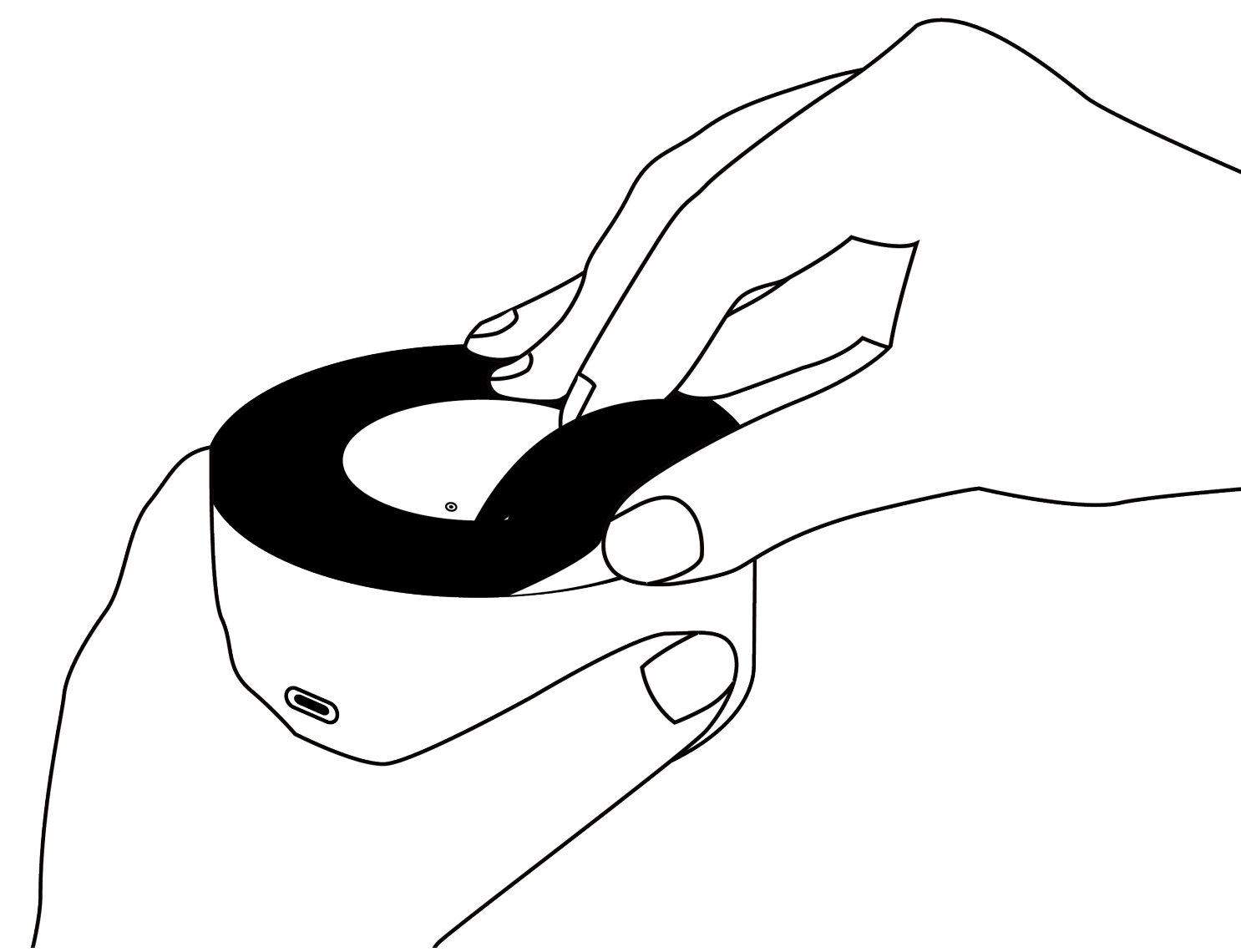

Peel off the old silicone ring by hand.

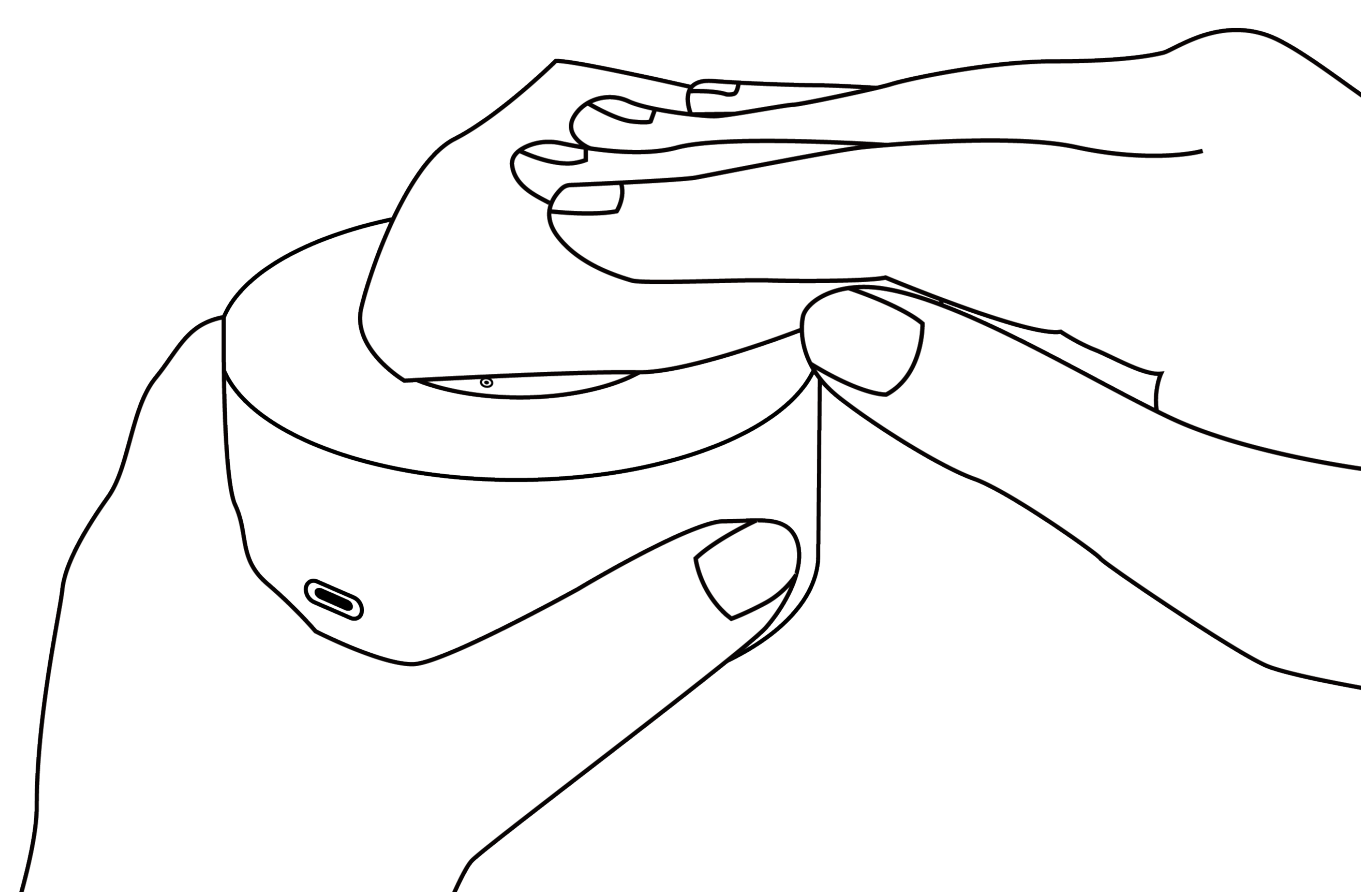

Clean the surface, then press the new ring flat.

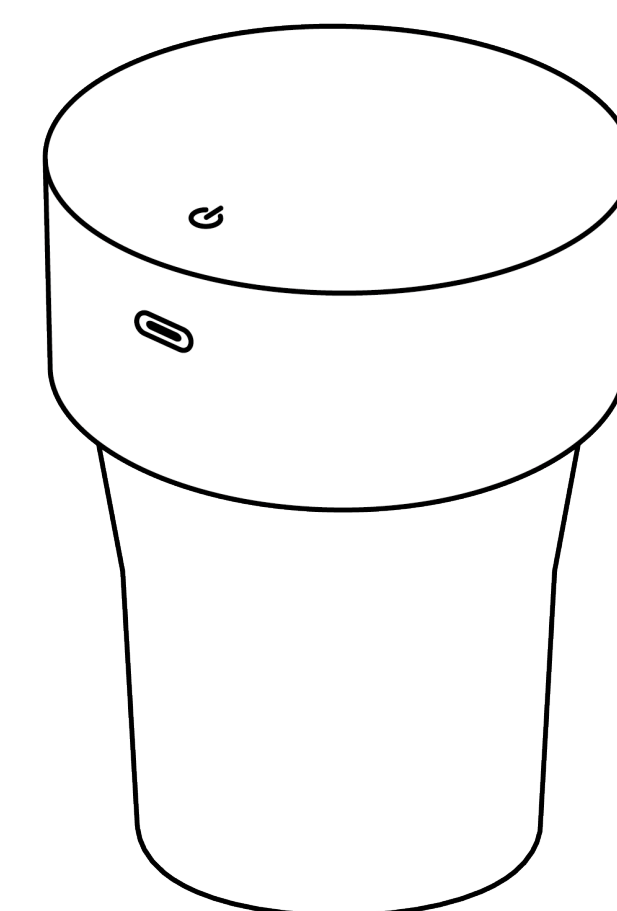

Place on a compatible cup and test depressurization.

1. Make sure the Horizon is **powered off** and **unplugged**.
2. Turn the Horizon upside down.
3. Peel the old silicone ring off the base by hand. No tools are required.
4. **Remove all adhesive residue from the base with a soft cloth dampened with warm water. Make sure the surface is clean and dry before installing the new ring.***
5. Remove the protective film from the replacement silicone ring, then place the ring on the base and press it flat against the surface.
6. Run your finger around the entire ring to ensure it sits **flat and even with no gaps**.

***Important: Any residue left on the surface may prevent the ring from sitting flat and cause seal failure. Clean with warm water and a soft cloth only. Do not use detergent or chemicals.**

Firmware Update

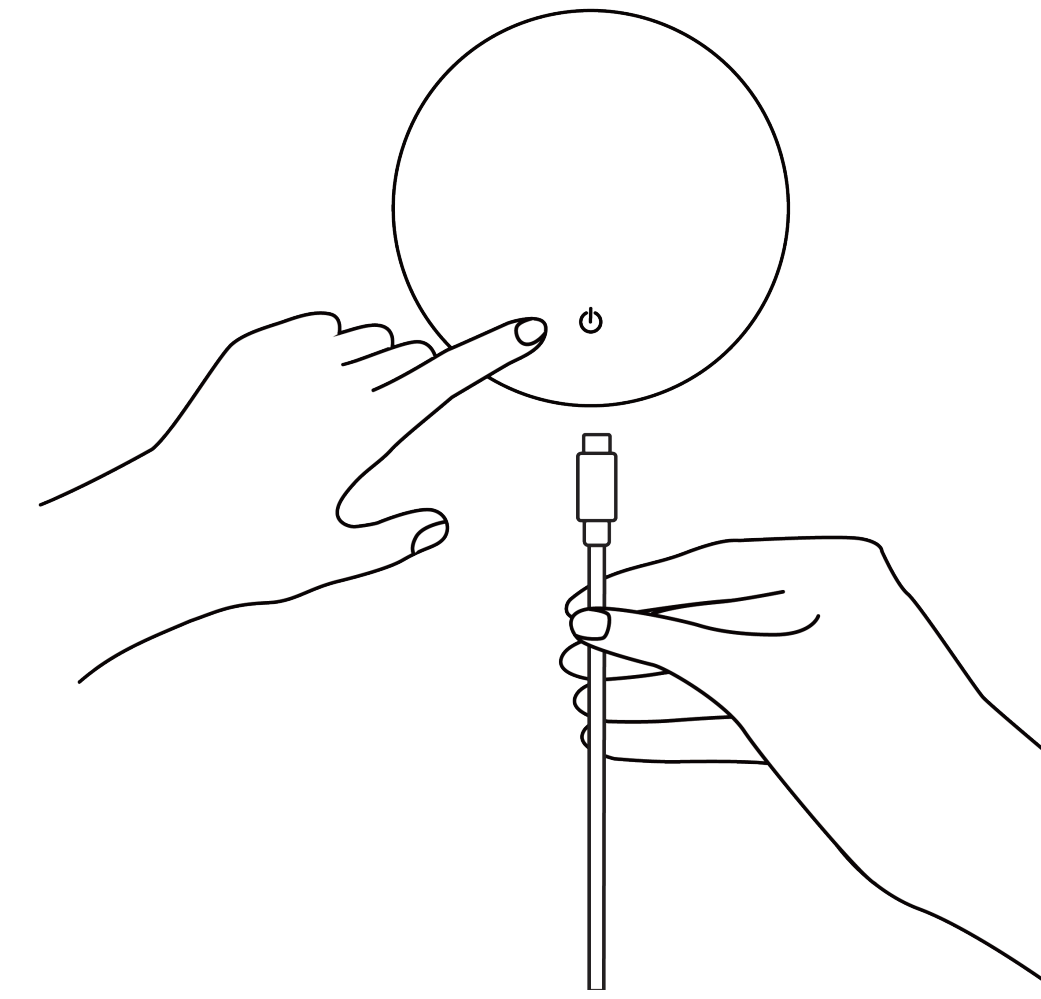

1. Use the Acaia Updater app to learn about the latest firmware releases and updates for the Horizon.

2. Press and hold the **Power** button while simultaneously connecting the charger. Continue holding for 10 seconds until the screen displays "**UPDATE**".

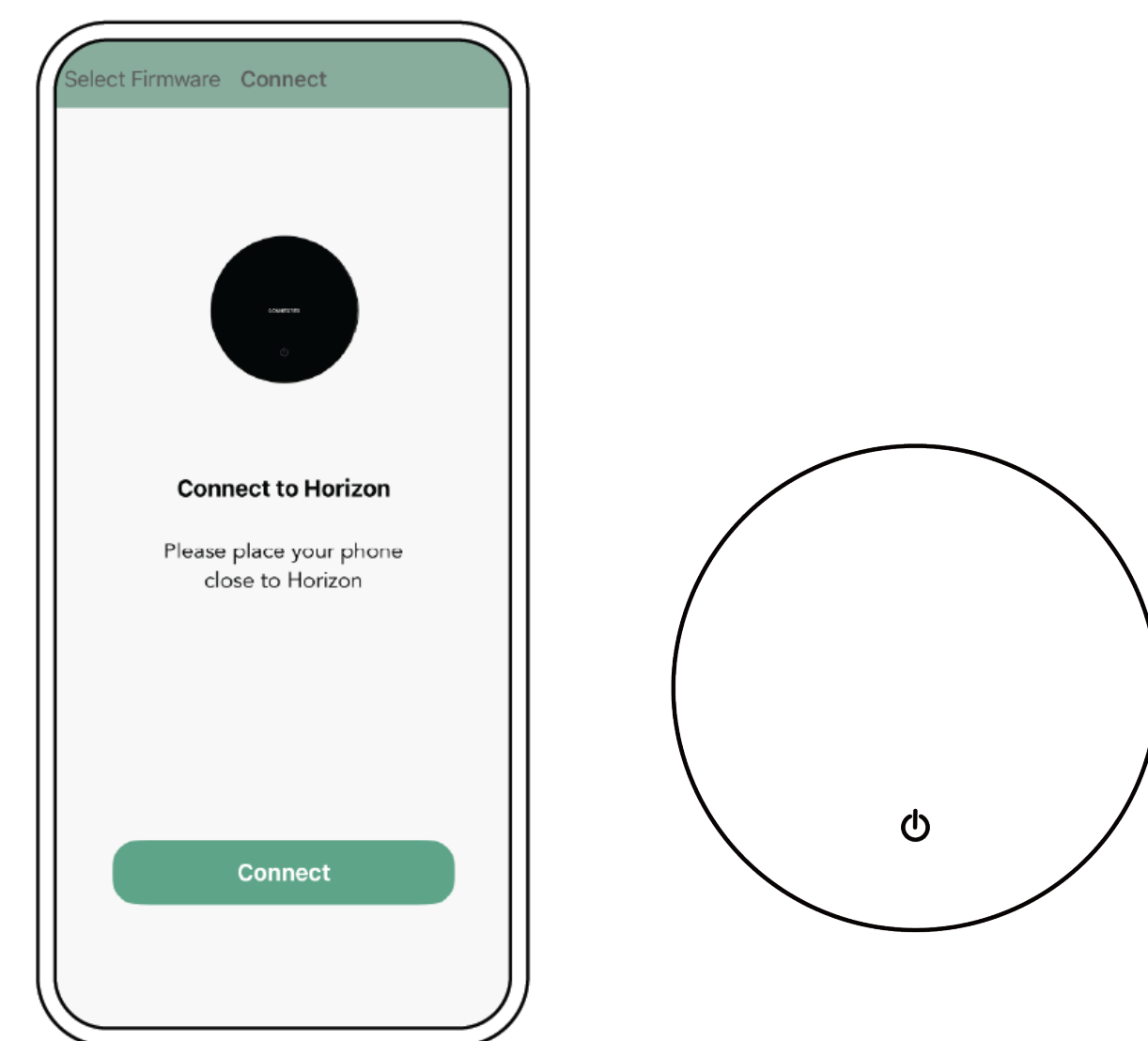
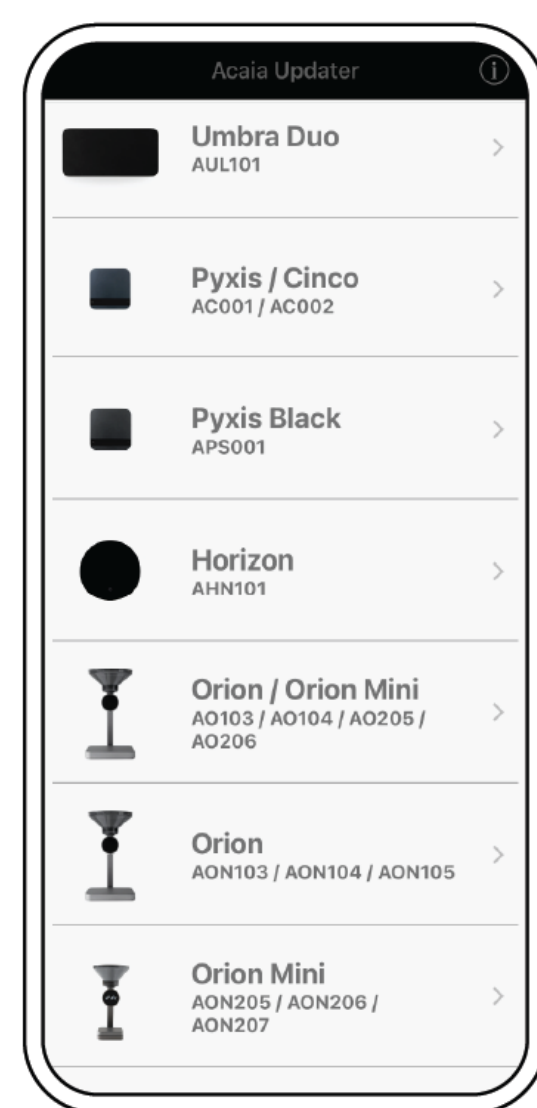

3. In the Acaia Updater app, select **Horizon (AHN101)**. The app will download the latest available firmware. Once the download is complete, please select **Next**.

4. Place your phone close to your Horizon, then tap **Connect** to automatically start the update.

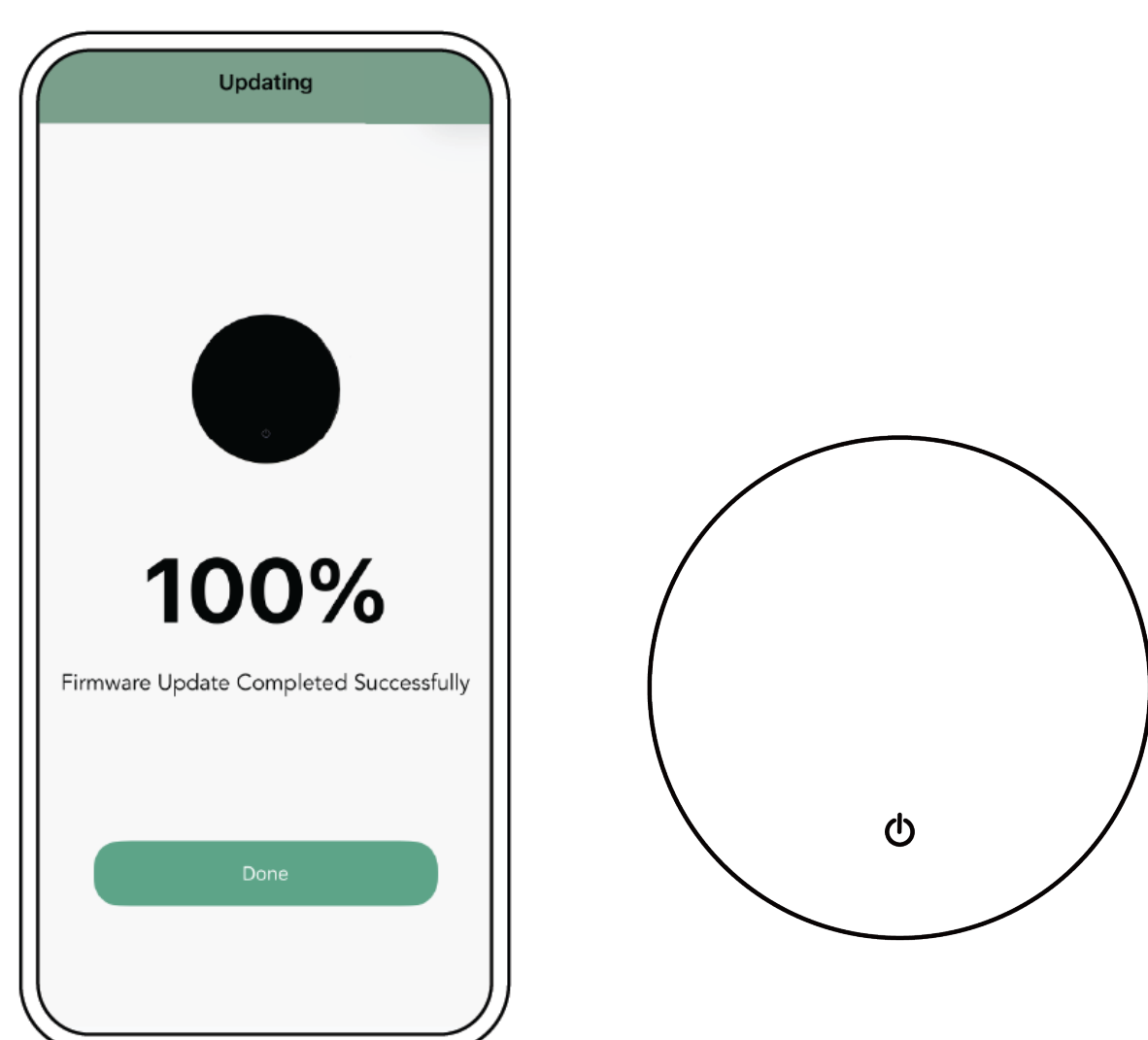

5. Once the update is complete, select **Done** in the Acaia Updater app, and the Horizon will automatically restart.

Note:

- Do not disconnect the charger before the update is complete, as this will cause the Horizon to exit Update mode.
- If the Horizon is not detected, ensure Bluetooth is enabled and the Horizon is in Update mode.
- Keep your phone close to the Horizon during the update process.

Troubleshooting

If depressurization cannot be completed, the progress bar will not advance and the screen will display "**DEPRESSURIZE ERROR**" after a few seconds. You can also manually cancel depressurization by pressing and holding the **Power** button. In either case, please:

1. Check if the battery level is sufficient. Charge the device if needed.
2. Ensure the silicone ring is centered, flush with the cup rim, and forms a proper seal.
3. Confirm the cup diameter meets the recommended size and has a continuous rim (no spouts, openings, or indentations).
4. Check that the vent hole is not blocked or obstructed.
5. Make sure the device is placed on a stable and level surface during operation.
6. Restart the device and try again.

If the issue persists, please email us at support@acaia.co and our team will be happy to assist.

Important:

- Do not cover or block the vent hole during use.
- Do not use the device with liquids that may spill into the vent hole.
- Do not rinse or immerse the product in water.
- Use only with compatible cups that form a proper seal.

Specifications

Model	AHN101
Product Weight	257 ± 5 g
Product Dimensions	Ø 87 mm, H 39 mm
Power Supply	5 V / 500 mA
Battery	Lithium-ion rechargeable 3.7 V 350 mAh
Battery Life	Up to 50 uses (varies with duration per use)
Material	Aluminum, Acrylic, Silicone
Connectivity	Bluetooth Low Energy 5.4
Inside the Package	Acaia Horizon x 1 Silicone Drip Mat x 1 USB-C Charging Cable x 1 Replacement Silicone Ring x 1 Product Care Cloth x 1 Acaia Sticker Set x 1 Warranty Information Card x 1

Copyright

This user manual is protected by copyright. All rights reserved. No part of this manual may be reproduced, processed, duplicated or published in any form by photocopying, microfilming, reprinting or any other method, in particular electronic means, without the written consent of Acaia.

© Acaia, California, 2026