

acaia



Acaia Orbit User Manual

**AOT007 / AOT008 / AOT009 /
AOT010 / AOT011 / AOT012 / AOT013**

Contents

3	Introduction
4	Safety Information
5	Parts Identification
6	In The Box
7	Setting Up the Orbit
8	Orbit Overview
9	General Information
9	Orbit Grinding
9	Start / Stop Grinding
9	Setting the grind on the Orbit
9	Adjust Grinding Speed
10	Hot Start / Cold Start
10	Knocker
10	Burr Zero Point
10	Burr Touch Point
10	Detent Ring
10	Stepless Adjustment
11	Auto-stop
11	Auto-purge
12	Reverse-And-Adjust
12	Stall Prevention
13	Advanced Control with the Orbit App
13	App Overview
14	When Connected to the Orbit
14	When Connected with Orbit and Lunar
15	RPM Profile Overview
16	Time-based Grinding
17	Manual Grinding
18	Settings Menu
20	Grind-by-weight with the Acaia Lunar
21	Grind-by-weight Workflow with the Acaia Lunar
25	Product Care Information
26	Appendix
28	Specifications

Introduction

Welcome to your new Acaia Orbit.

The Orbit is a 64 mm flat burr grinder built with the latest Acaia technology from the ground up. Designed for home and light commercial spaces, the Orbit is convenient and versatile. It will optimize your workflow and offer a coffee grinding experience like never before.

The stepless grind size adjustment dial is intuitive and precise. With the built-in auto reverse cleaning process and a knocker, grind retention for single dosing is kept at a minimum.

The companion Orbit app gives you full control of the Orbit. You can personalize the button behavior, experiment with RPM profiling, or even control the RPM manually through the app.

Grind precisely the right amount every time with Acaia Sense Technology. The Orbit can connect with the Lunar and become one of the most precise grind-by-weight grinders in the industry.

With the Orbit, a new coffee grinding experience awaits. Follow this guide to explore all that it has to offer.

Safety Information

Read the information below very carefully before using your Orbit. It contains important safety information for this appliance. Incorrect handling of this product could result in personal injury or physical damage. Please keep these instructions for future reference.

- ! Before cleaning, servicing, and assembling / disassembling the grinder, unplug the electrical supply and wait for at least 5 minutes.
- ! Use only an AC power source with voltage within the product specification.
- ! Never immerse the grinder in water.
- ! Never place fingers or any objects inside the Orbit Spout.
- ! Never operate the Orbit without the Orbit Spout properly installed.
- ! Never operate the Orbit without the Hopper properly installed.
- ! The Orbit is intended to grind roasted whole coffee beans only.
- ! For EU: This appliance can be used by children aged from 8 years and above, and people with reduced physical, sensory, mental capabilities, or lack of experience and knowledge, if they are under supervision or have been given instructions concerning use of the appliance in a safe way and understand the hazards involved.
- ! For EU: Children shall not play with the appliance. Cleaning and user maintenance shall not be made by children without supervision.
- ! For other than EU: The appliance is not to be used by people (including children) with reduced physical, sensory, mental capabilities, or lack of experience and knowledge, unless they are under supervision or have been given instructions.
- ! Instructions include the use of accessories.
- ! This appliance is intended to be used in household and similar applications such as:
 - staff kitchen areas in shops, offices, and other working environments;
 - farm houses;
 - by clients in hotels, motels, and other residential type environments;
 - bed and breakfast type environments.

Parts Identification

No.	Description	QTY
1	Motor housing cover	1
2	m3x8mm self-tapping screw - black	10
3	Motor	1
4	Cable bracket	1
5	m5x12mm screw	4
6	Connecting shaft	1
7	Bearing	1
8	Bearing Shaft	1
9	m3x12mm screw for e-ring	2
10	Hopper Cover (*Hopper finger guard)	1
11	Multi-Purpose Hopper (*Hopper)	1
12	e-ring d2.5	2
13	Bean chamber	1
14	d3x4mm ball plunger	2
15	5x5mm magnet	5
16	Detent ring	1
17	SECC plating	1
18	d4x6.5mm ball plunger	3
19	Adjustment dial	1
20	Adjustment dial mylar	1
21	Burr thread	1
22	64mm burr	1
23	m5x8mm screw	6
24	Burr carrier	1
25	m2.5x6mm screw	7
26	Bearing	1
27	m4x12mm screw - black	4
28	m4x8mm screw - black	2
29	Washer	6
30	Burr housing	1
31	Knocker ring	1
32	Knocker spring	1
33	Spout	1
34	Spout springs	2
35	m3x8mm screw i-head - black	2
36	Support bracket	1
37	m3x5mm screw i-head - black	2
38	LED cover	1
39	LED	1
40	m3x8mm screw flat head	3
41	Support pillar	1

No.	Description	QTY
42	Power sponge	2
43	Power supply	1
44	Power bracket	1
45	m3x5mm i-head screw	8
46	Base chassis	1
47	Switch cover	1
48	Ø 15x1mm magnet	1
49	m2x4mm screw	4
50	LED switch pcb	1
51	Switch bracket	1
52	m8x5mm magnet	4
53	Orbit main control board	1
54	3x8mm i-head screw	4
55	Power plug	1
56	Main power switch	1
57	Base	1
58	Rubber foot - black	4

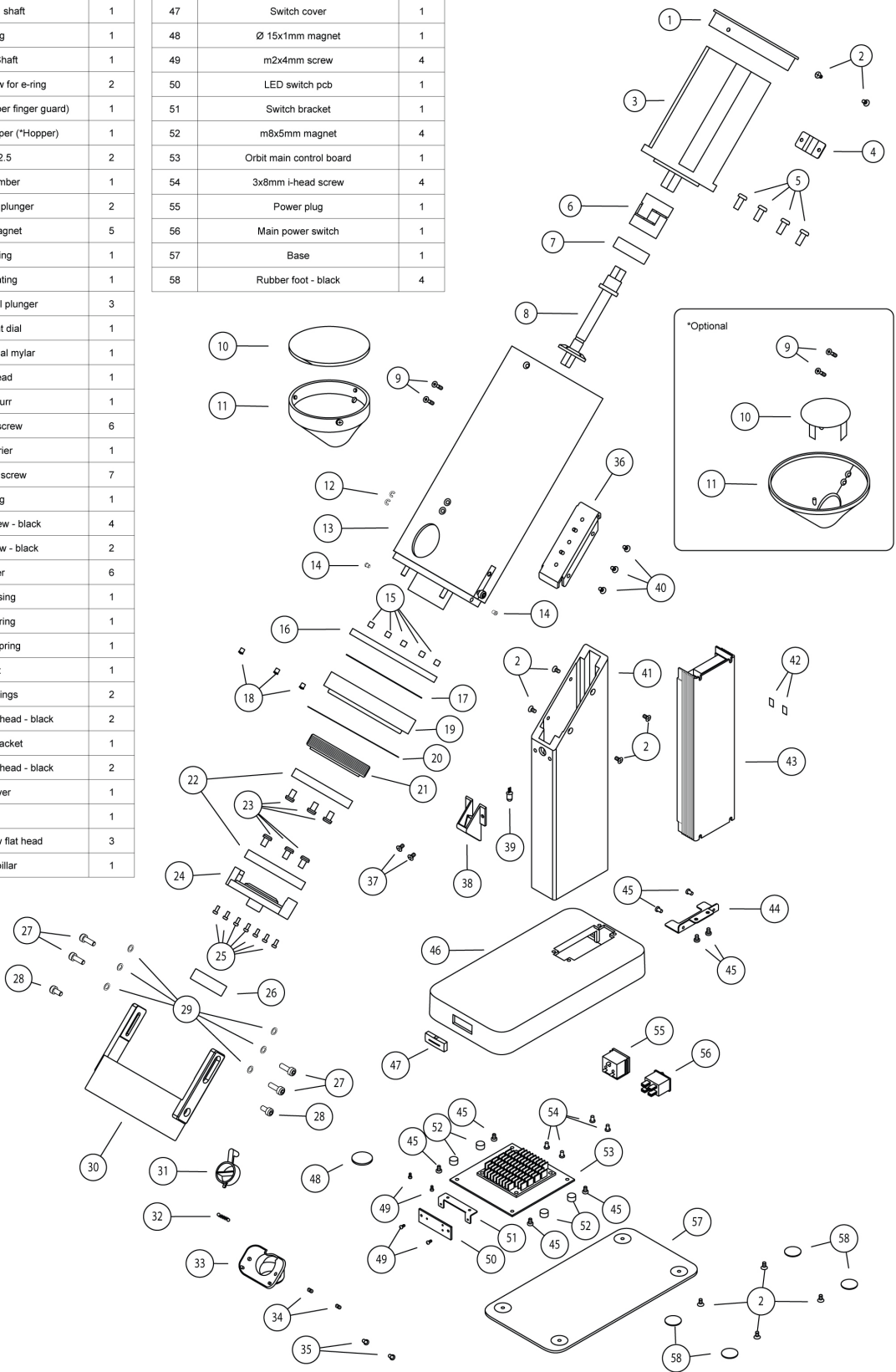

In The Box



**Orbit Coffee
Grinder**



Power Cable



**58 mm Portafilter
Dosing Cup with
Magnetic Pad**



**Lunar Magnetic Strips
Application Tool**



Accessory Tool Kit

- Spout Extender x 1
- Hex Wrench x 1
- Lunar Metal Magnetic Strips x 4
- Burr Carrier Screws x 6
- Spout Screws x 2
- Touch Point sticker x 5
- Knocker spring x 2
- m4x12mm screw x 4
- m2.5x6mm screw x 4
- Washer x 4

Setting Up the Orbit

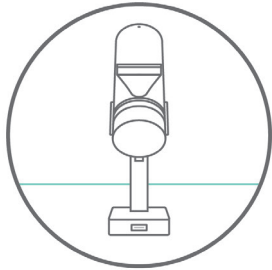

Place the Orbit on a flat, stable surface.

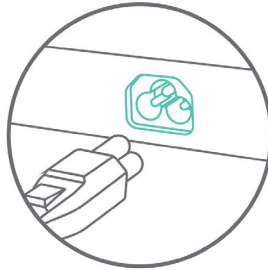

Plug into a 100V~240V AC power source.

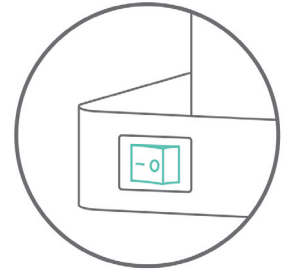

Turn on the main power switch at the back.



Attach the spout extender to the Orbit spout. (Optional)

*Note: It is advised to remove the spout extender when using with the Lunar scale in Grind-By-Weight mode.



Place the 58 mm Dosing Cup on the base of the Orbit.



Click the Orbit button in the front. When the button light is on, you are ready to go.

Note:

- Acaia tests every unit with coffee beans during the quality control process. Some ground coffee may remain in the grinder or the packaging.
- Please avoid setting the dial beyond the burr touching point.

Orbit Overview

- Click
- Double Click
- Triple Click
- Press and Hold

Hopper



*Optional

Grind Adjustment Ring
Reference Mark

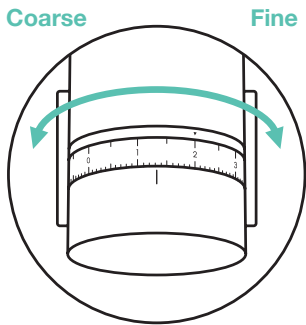

Detent Ring



You can adjust the detent ring to suit your needs.

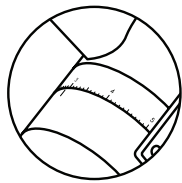

*Model AOT007 / AOT008 / AOT009 / AOT010 comes with a wide adjustment ring.

Spotlight

Knocker

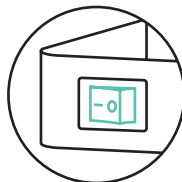

Main Power Switch

Orbit Button

- Power on
- Start / Stop / Pause*
- Pulse
- Purge
- Toggle preset (2 seconds)
- Standby (10 seconds)

*The Orbit will auto standby when not in use.

Light Indicators		
	White	Preset A (600 RPM)
	Blue	Preset B (1000 RPM)
	Cyan	Preset C (1500 RPM)
	Magenta	Manual Mode
	Red	Warning / Firmware update
	Green	Reset to factory default
	Yellow	Purge / Cleaning in progress
	Orange	Connecting in progress

General Information

Orbit Grinding

The Orbit comes with unique features to meet your coffee brewing needs. The grinder is single-dosing friendly with features such as automatic cleaning purge that helps to reduce retention when grinding. You can also activate Orbit's grind-by-weight function by pairing with the latest Acaia Lunar and enjoy an effortless dosing experience.

Built and designed with Acaia's proprietary technology from the motor driver to the companion app, Orbit offers advanced control of RPM and overall energy savings. See the information below to explore the features of Orbit.

Start / Stop Grinding

Click the Orbit button to easily start / stop a grinding session.

Setting the grind on the Orbit



Setting the grind on the Orbit is controlled by the Grind Adjustment Ring, which is located just below the hopper. Turning counterclockwise makes the grind more coarse, and clockwise more fine.

Using the burr touch point as a reference, we suggest the following grind settings:

Espresso: +2 to +3	Manual pour over: +5 to +10
Moka pot: +4 to +5	Batch filter: +6 to +12
Aeropress: +4 to +8	French press and cold brew: +7 to +12

Adjust Grinding Speed

Press and hold the Orbit button to switch between 3 default RPM profiles. The 3 presets are each represented by a different color light. You can access the RPM profiling feature through the Orbit app.

LED Indicator Color	Preset Name (In App)	Preset RPM
White 	Preset A	600 RPM
Blue 	Preset B	1000 RPM
Cyan 	Preset C	1500 RPM

Hot Start / Cold Start

You can either start grinding by adding beans into the Orbit while the grinder is started (hot start) or before it is started (cold start). Note that the particle distribution of the ground coffee may slightly change depending on the way you start grinding.

Knocker

The knocker is just behind the Orbit spout. Use the knocker 2 to 3 times to knock out as much retention as possible. You can change the direction of the knocker for left-handed or right-handed users. Please refer to our Orbit videos list on how to change the orientation of the knocker.

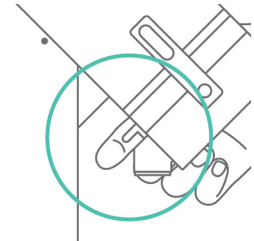

Burr Zero Point

The point where the burrs can no longer be adjusted finer. When turning the adjustment dial finer, it will encounter total resistance and will not be able to turn.

DO NOT attempt to turn on the grinder when burrs are at zero as damage may occur. Note that the “0” on the grind adjustment ring does not equal the Burr Zero Point for your Orbit.

Burr Touch Point

The point where the burrs make initial contact with each other and make an audible sound of metal-on-metal scraping. This is the finest possible grind setting. If performing a burr alignment or installing new burrs, the burr touch point may change position. Attempting to grind finer than the burr touch point may result in damage to the burrs or motor.

Detent Ring

The detent ring is a moveable ring that sits above the adjustment ring. It is marked with symbols that can be used as reference points for grind settings.

Stepless Adjustment

Orbit's setting dial has a 0.75 mm thread pitch that allows smooth and continuous adjustment from espresso to filter coffee in just one rotation. That gives plenty of room to fine-tune your shots, as well as swap from small pour over brews to large batches whenever you need to.

Auto-stop

The Orbit will automatically stop grinding once the bean chamber is empty after 5 seconds. If the Orbit is turned on without any beans in it, the grinder will automatically stop after 15 seconds.

You can adjust the auto-stop setting through the Orbit App for continuous grinding. Once the auto-stop setting is turned off, the grinder will continue grinding until it is manually stopped by the Orbit button.

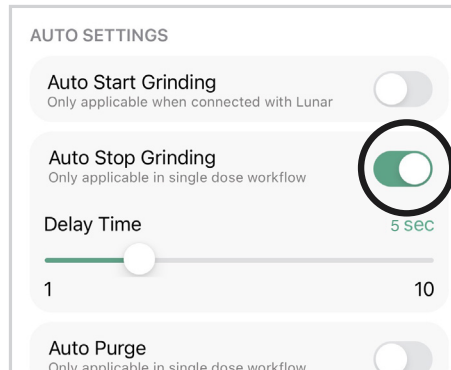
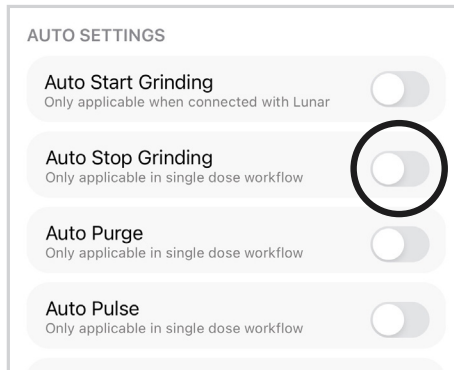

Auto-purge

Orbit will automatically purge after each grind to reduce the retention. The Orbit will show a yellow light when in purging with a fast reverse spin, then a forward spin. You can manually trigger the purging sequence by triple clicking the Orbit button.

This setting can be turned off through the Orbit App. Once turned off, the Orbit will not auto-purge after each grind.

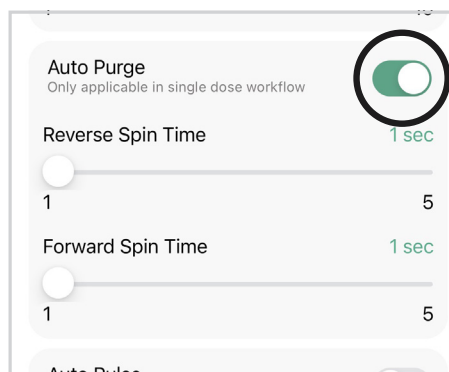
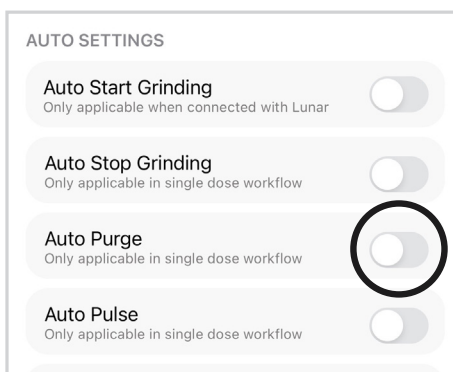

Reverse-And-Adjust

Utilize the “Reverse-and-Adjust” function for effortless switching between filter and espresso grind settings.

Select “Orbit Button Action” and assign one of the button functions to “Reverse-And-Adjust.” This feature is unique to the Orbit grinder. When you trigger the action button with a triple click, the burrs will continuously reverse, expelling coffee particles. After just a few seconds of reversing, the dial can be adjusted finer as usual.

General tips:

- Before adjusting the dial, try the Orbit Purge (triple click).
- Keep the grinder running while adjusting the dial, following common practice in most other grinders.
- Add a few coffee beans and grind them while adjusting the dial back and forth simultaneously. This action helps dislodge and clear any stuck particles.
- Utilize the triple-click feature to reverse spin the burr at a low RPM, making it easier to adjust the dial from coarse to fine, even if coffee particles are lodged between the burrs.

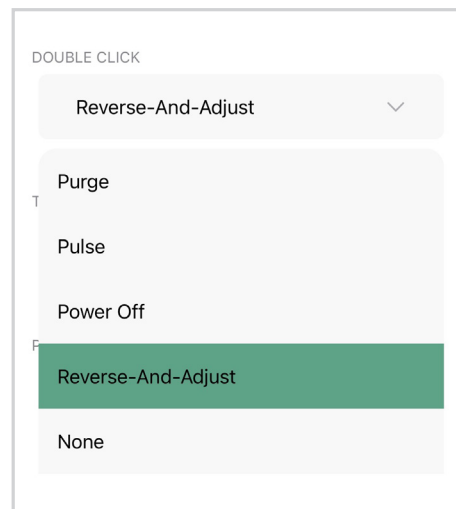

Stall Prevention

When grinding, if the Orbit burrs stall and stop grinding, it will automatically stop the motor. The button will flash red to notify the user that a stall has occurred, and the Orbit will then restart the motor to try to grind again.

In many cases, the momentary pause and restart will correct the stall and grinding will continue successfully.

After stalling 5 times, the Orbit will stop the motor and will not attempt to restart again. In this case, you may need to adjust the grind coarser and try again, open the grinder to clear a piece of debris (such as a piece of concrete or wood that was mixed in with the beans), or contact customer service for support.

If the Orbit encounters extremely hard beans or rocks and any other foreign objects, it may shut down automatically without warning immediately to protect the system from overloading. If this issue occurs, please follow our deep cleaning instructions and remove any beans or foreign objects.

Note:

- **To see our single-dose grinding workflow, go to the Orbit videos list on the Acaia YouTube Channel.**
- **The auto-stop and auto-purge function are both ON by default. The auto-purge sequence will only be initiated when the auto-stop function is on.**
- **The Orbit should only be used to grind roasted coffee beans. Attempting to grind other materials or products may result in damage or malfunction of the grinder.**

Advanced Control with the Orbit App

The companion Orbit App gives you advanced control over the Orbit. You can fully customize your Orbit by adjusting button actions, RPM profiles, and other settings.

App Overview

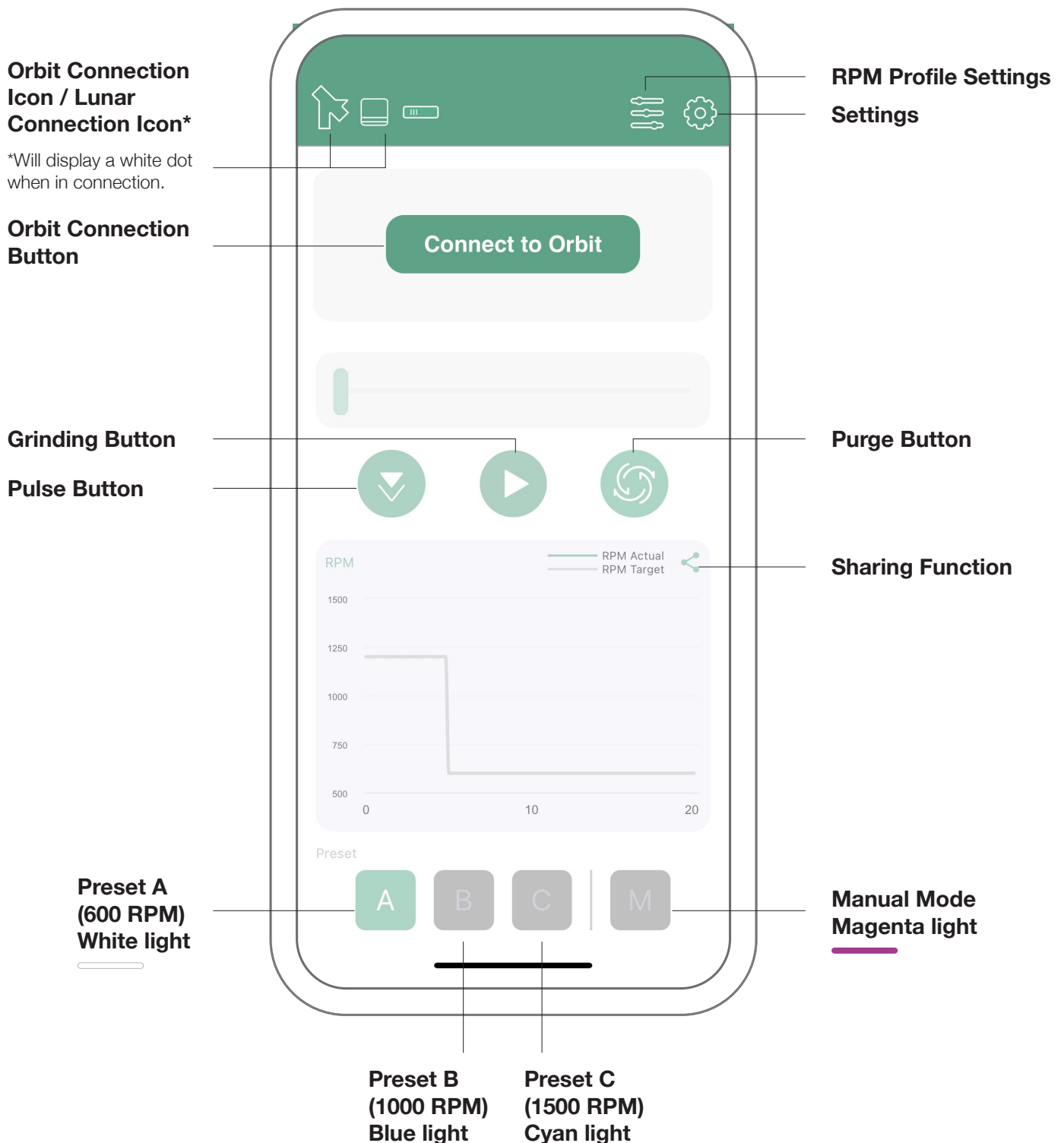

When Connected to the Orbit

A white dot will appear on the upper left Orbit icon in the upper left corner.

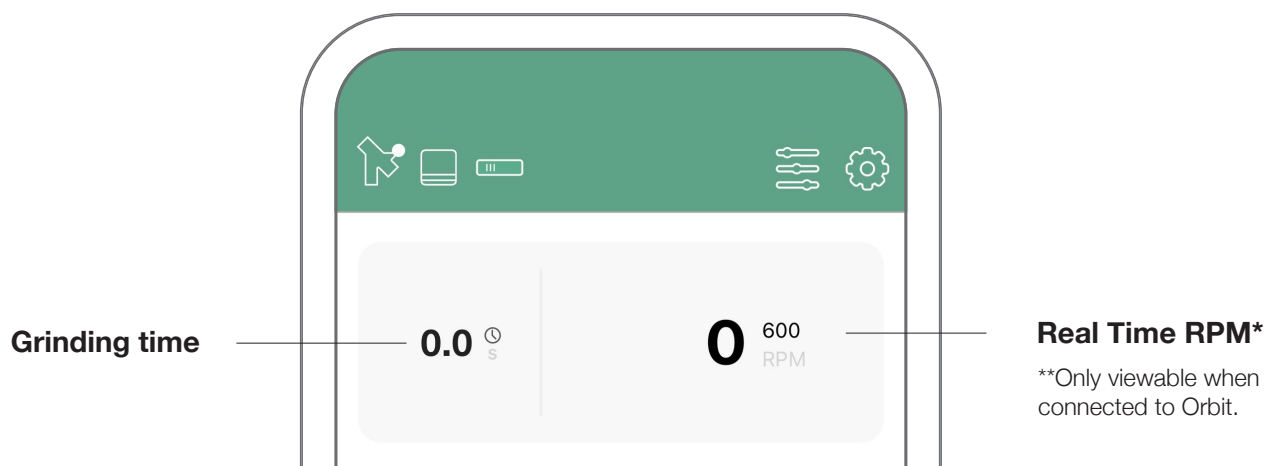

When Connected with Orbit and Lunar

A white dot will appear on both the Orbit and the Lunar icon in the upper left corner.

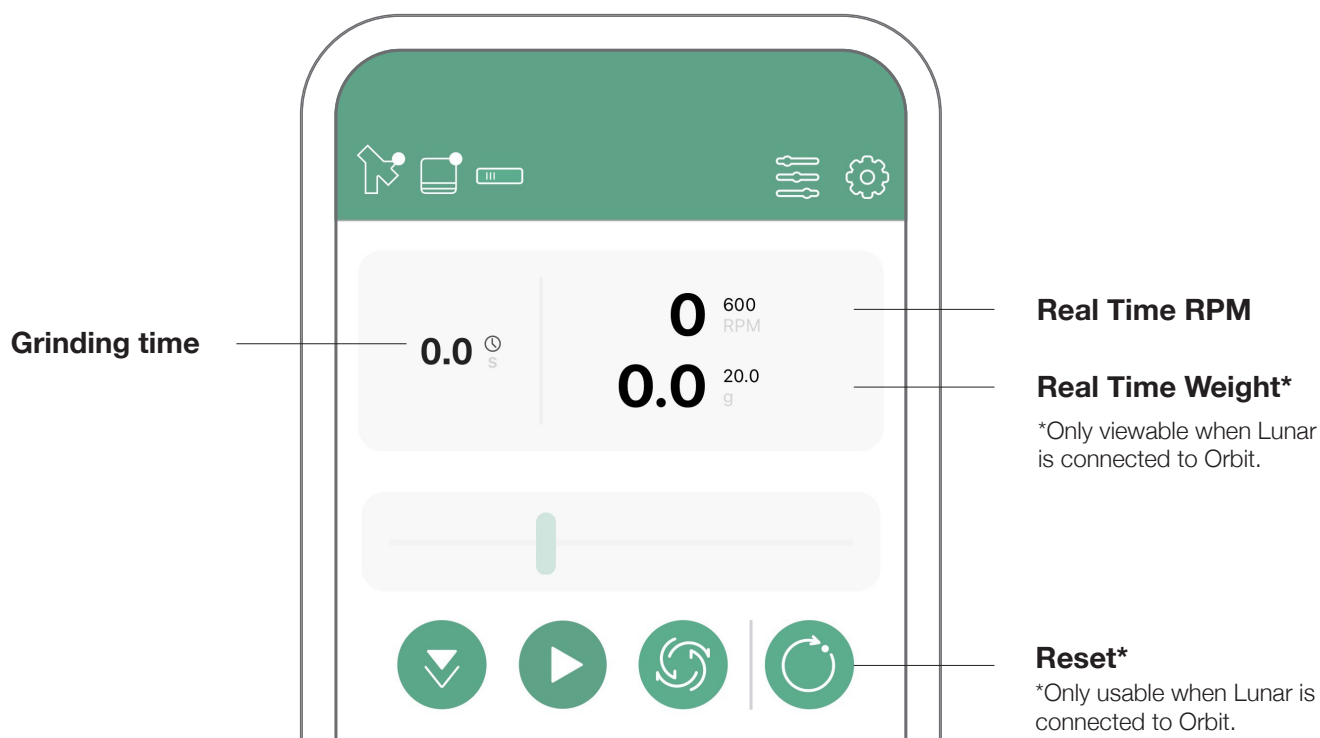

RPM Profile Overview

The Orbit features Acaia's first-in-class RPM profiling, which allows you to explore new particle size distributions created by shifting the RPM of the grinder. When grinding coffee, the rotation speed of the burrs (RPM) has an effect on the uniformity of the grinds created. With the Orbit, you can design your own RPM profile to experiment with how shifting RPM affects the uniformity and flavor of your brews.

To access the RPM profiling feature, first connect the Orbit app to your Orbit grinder. For each profile (A, B, and C) you can set a 2-stage RPM profile. The stages can be set between 600-1500 RPM, and include a timer to set how long each stage should run. RPM profiling is only available while the Orbit is connected to the Orbit app. RPM profiling is not available in grind-by-weight mode. The modified settings from the app will be saved to the Orbit, and first stage settings will be saved into the App preset.

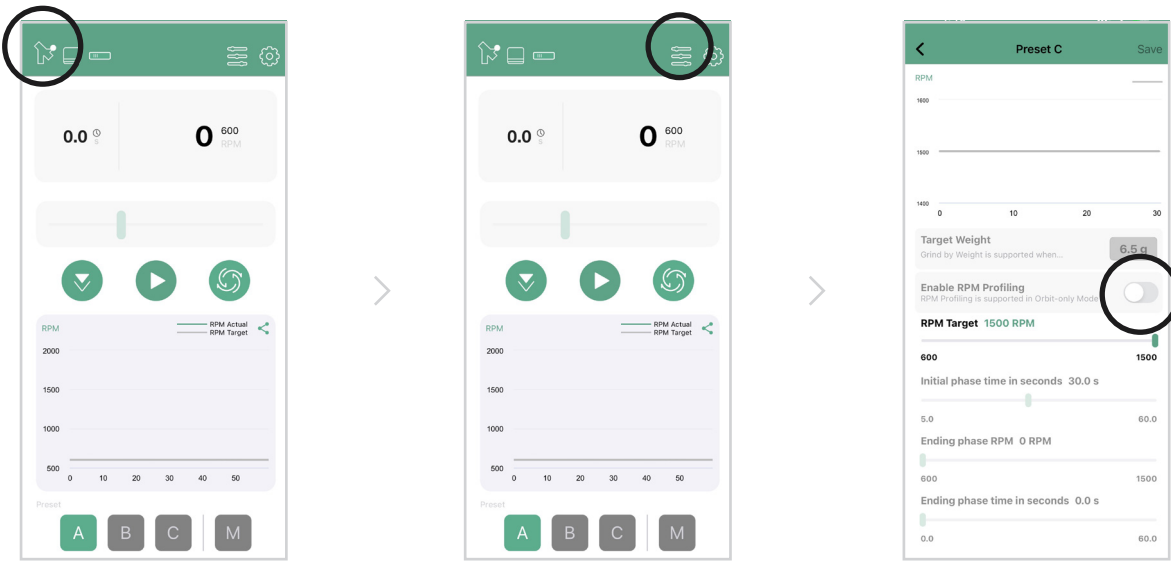

- 1 To adjust this setting, first make sure you are connected to Orbit through the app.
- 2 Choose either Preset A, B, or C. Enter the RPM profile settings.
- 3 Enable the RPM profiling option. (Not available in Grind-by-weight mode)

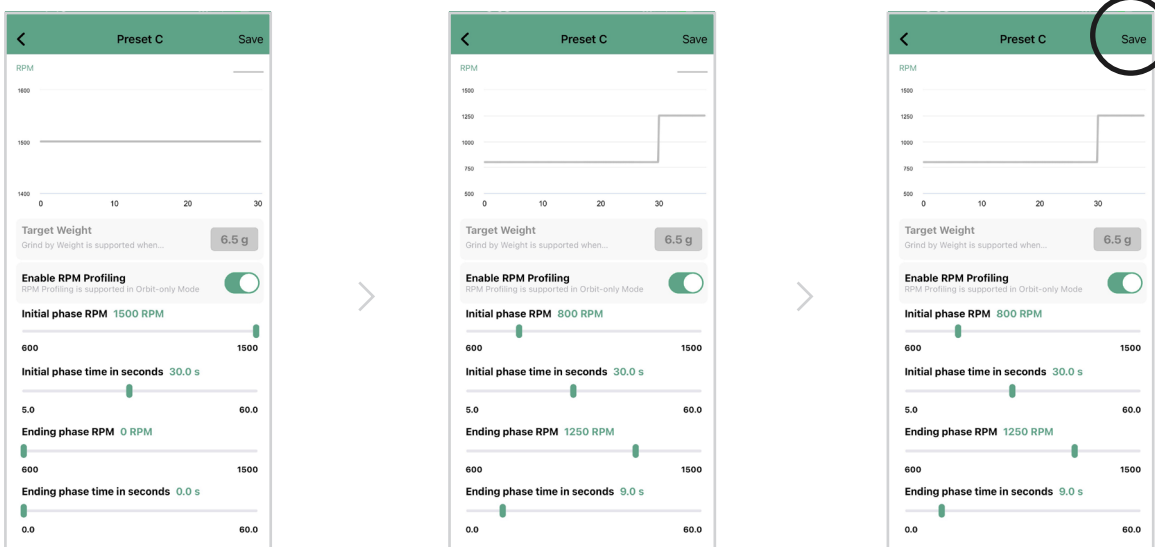

- 4 When RPM profiling is enabled, the adjustable options will become active.
- 5 You can adjust the RPM profile settings as desired.
- 6 Click [Save] in the upper right corner to save the modified settings into the Orbit.

Time-based Grinding

The Orbit has a time-based grinding function that is only accessible through the Orbit App. You can set the desired grinding time for each grinding session. The grinder will automatically stop when the target time is reached.

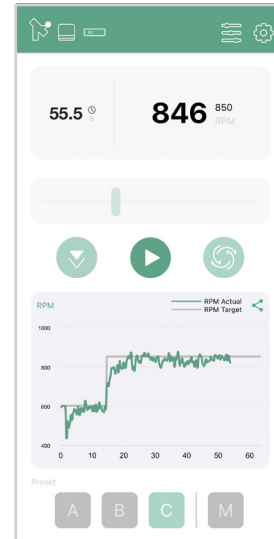
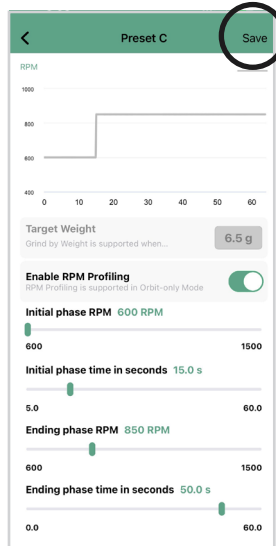
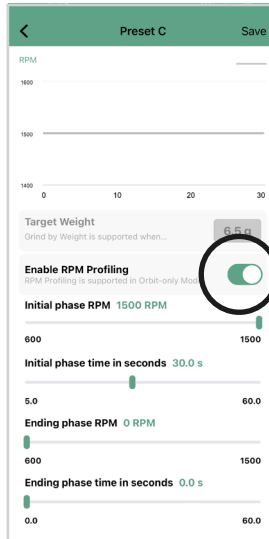

- 1 When RPM profiling is enabled, adjust the initial and ending phase times to control the duration of a grinding session.

- 2 Save the settings through the upper-right corner.

- 3 Once the settings are saved, the Orbit will stop grinding when the ending phase time is reached.

Manual Grinding

Orbit's manual grinding mode enables you to control the RPM freely in real time. During a single grinding session, you can change the speed of the grinder by simply dragging the RPM slider in the Orbit App. You can see the real time RPM graphed in the chart on the App main page.

The Orbit will display a Magenta light when in manual mode. Please note that RPM profiling is not available in manual mode.

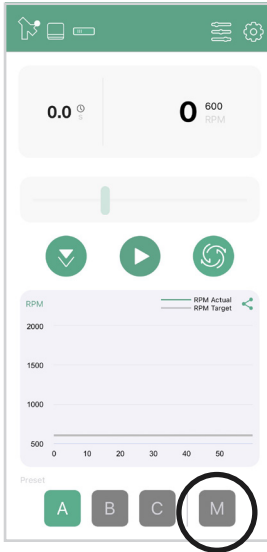

1 Connect to Orbit through the Orbit App and choose Preset M (Manual Mode.)

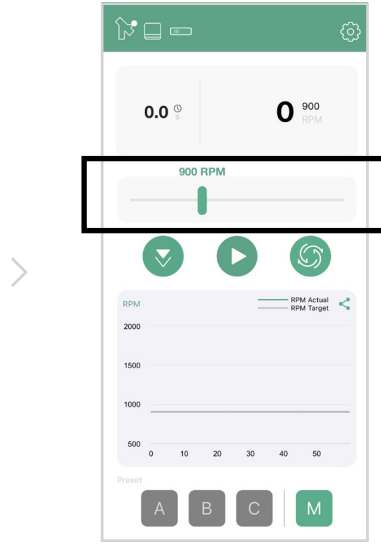

2 The RPM slider becomes active when switched to Manual mode.

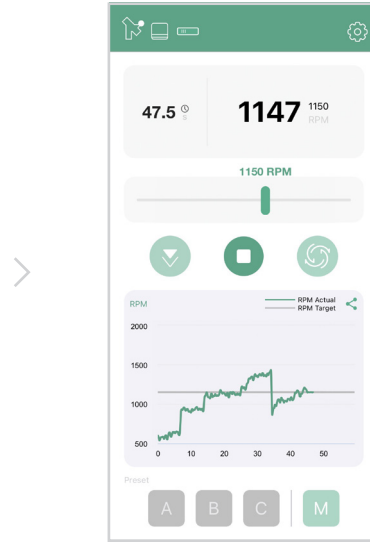

3 Use the slider to adjust the speed of the grinder. The real-time RPM will be displayed by the green line in the graph below while target RPM is displayed by the gray line.

Settings Menu

Tap the settings icon on the upper right corner of the Orbit App main page to enter Orbit App settings. The overall settings are listed below:

Orbit Button Actions

You can also design your own workflow by customizing the Orbit button actions through the App. There are three button actions customizable: Double Click, Triple Click, Press and Hold for 10 seconds. The customizable options are Pulse, Purge, Power Off, and Reverse Burr Setting.

Please note that the action [Click] is set to power on, start, and stop. This action is not customizable.

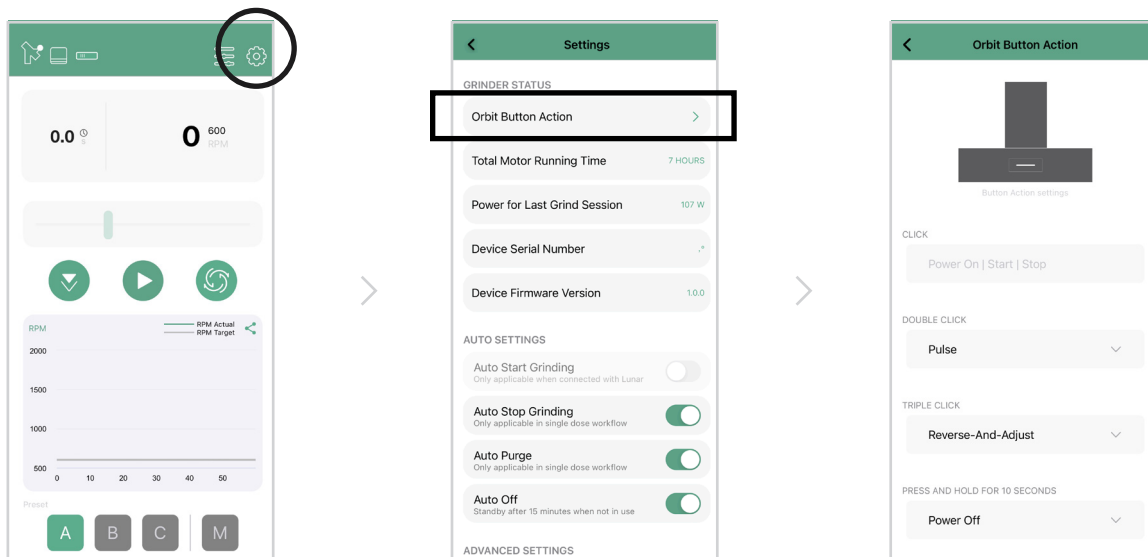

- 1 Connect your Orbit to the Orbit App. Enter the Settings Menu through the icon in the upper right corner.
- 2 Tap [Orbit Button Action] at the top of the setting page.
- 3 Customize the action buttons for Purge, Pulse, Reverse-And-Adjust, or None.

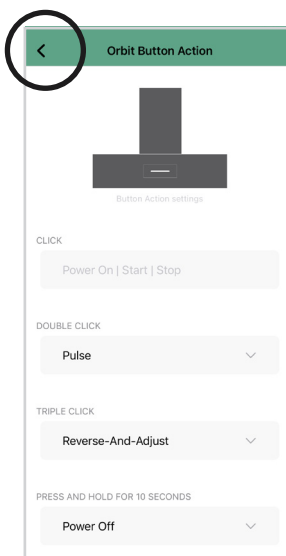

- 4 Tap < to exit the settings page and save your changes.

Reverse-And-Adjust

Utilize the “Reverse-and-Adjust” function for effortless switching between filter and espresso grind settings. Please refer to Page 11 for detailed instructions.

Auto Start Grinding

1. The default setting is OFF.
2. On: Auto Start enabled; Orbit automatically starts grinding once a cup or container weighing more than 5 grams is placed on Lunar.
3. Off: Auto Start disabled; start grinding by clicking the Orbit button.
4. Auto Start is only supported in grind-by-weight mode. You may also enable the Auto Start Grinding via the Lunar scale. In Manual mode, press and hold the Tare button for 3 seconds to enable/ disable the Auto Start function.

Auto Stop Grinding

1. The default setting is ON.
2. On: Auto Stop enabled; grinder will automatically stop grinding when
 - 5 seconds after grinding session ends.
 - No coffee beans are detected for around 15-17 seconds after a grinding session is started.
3. Off: Auto Stop disabled. Auto Purge will also be disabled.
4. Auto Stop is only supported in single dose grinding.

Auto Purge

1. The default setting is ON. Auto Purge Setting can only be turned on when Auto Stop Setting is on.
2. On: Auto Purge enabled.
3. Off: Auto Purge disabled.
4. Auto Purge is only supported in single dose grinding.

Auto Off

1. The default setting is ON.
2. On: Auto Off enabled; Orbit automatically enters standby mode after 15 minutes.
3. Off: Auto Off disabled.

Clear Paired Acaia Scale

Tap [Clear] to clear the paired Acaia Lunar. Each orbit can only pair with one Lunar at a time. If you wish to pair with another Lunar, please reset the pairing through the App, or reset the Orbit to factory default.

Reset to Default

Tap [Reset] to reset Orbit to factory default. All settings including RPM profiles, button actions, and pairing will be reset to factory default.

Enable / Disable Acaia Scale Connection

1. The default setting is ON.
2. On: Connection to Acaia Scale enabled; Lunar will automatically pair / connect to Orbit when placed on the Orbit.
3. Off: Connection to Acaia Scale is disabled; Lunar will **NOT** automatically pair / connect to Orbit when placed on the Orbit.

Grind-by-Weight with the Acaia Lunar

Mode Introduction

The Orbit comes with a grind-by-weight mode that can be activated through a paired Acaia Lunar. In grind-by-weight mode, you can set the target weight and desired RPM for your grinding session. The grinder will automatically stop grinding once the target weight is reached.

Acaia Sense Technology

When the target weight is reached, the Orbit will automatically stop the motor and complete the grinding session. With the machine learning Acaia Sense technology built in, the predictive offset will be dynamically adjusted each time to ensure the most accuracy and repeatability of the dose in grind-by-weight.

Acaia Lunar on Orbit

You can enable the grind-by-weight mode by connecting the Orbit to the Lunar. With the Lunar connected, the Orbit supports 3 customizable presets for weight-based grinding, also including an auto-start grinding function to give you a hands-free operating experience.

See the instructions in the next section on how to pair your Lunar to Orbit and how the Lunar functions when connected to the grinder.

Auto-Grinding for Hands-free Operation

The Orbit bears an auto-start function that supports an auto-grinding workflow. With the auto-start and auto-stop setting both enabled, you can grind easily by just placing your cup on the paired Acaia Lunar. The Orbit will start grinding once a cup weighing more than 5 grams is placed on the Lunar, and stop when the target weight is reached.

You can enable the auto-start setting via the Orbit App, or through the paired Acaia Lunar.

- Open the Orbit App or use the paired Acaia Lunar.
- If using the Lunar, ensure it is connected to the Orbit.
- Switch to Manual Mode; the Orbit button will turn Magenta.
- Press and hold the T button on the Lunar scale until [Ato On] is displayed.
- Switch back to your desired RPM profile to activate Auto-grinding.
- To disable Auto-Start grinding, switch to Manual mode again.
- Press and hold the T button on the Lunar scale until [Ato OFF] appears.

Grind-by-Weight Workflow with the Acaia Lunar

Follow the steps below to set up the grind-by-weight function with the Acaia Lunar.

Apply Lunar Magnetic Strips

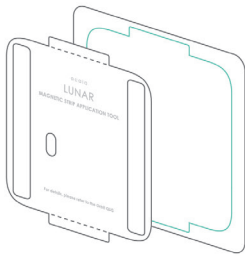

- 1 Remove** the Lunar magnetic strips application tool along the dotted line.



- 2 Fold** the flaps at the top and bottom of the application tool along the dotted line.

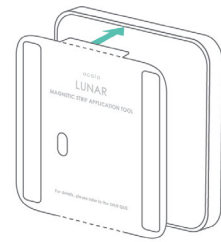

- 3 Align and insert** the application tool flaps into the Lunar base gap.



- 4 Peel off** the backing paper of the magnetic strips.



- 5 Align** the magnetic strips with the application tool and attach the strips to the Lunar.





- 6 Remove** the application tool.

Note:

The Lunar metal magnetic strips cannot be repeatedly pasted. Before attaching the Lunar, you must clean the bottom of the Lunar thoroughly, then attach the magnetic strip. You also need to apply pressure to flatten the magnetic strip to ensure it sticks firmly. If the strip is not securely attached and shifts, the adhesive on that magnetic strip will be damaged and cannot be reused.

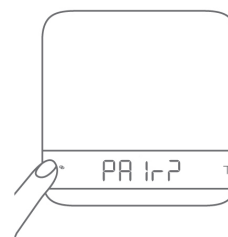
Pairing with the Lunar for the First Time



- 1** Make sure both the Lunar and the Orbit are using the latest firmware via the Acaia Updater App.
- 2** Check if the Lunar has the magnetic strips aligned correctly.
- 3** When the Lunar is off, **press and hold** the  button for 10 seconds until the LED displays 'Pair?'.

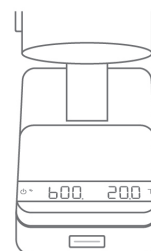
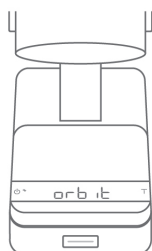

- 4** **Place** the Lunar on the Orbit. When the Orbit button turns orange and the Lunar displays 'Confirm?', **tap** T on the Lunar to confirm pairing.
- 5** When the Lunar displays 'Orbit', the pairing is complete.
- 6** You will only need to pair the Lunar once. The Lunar will automatically connect with the Orbit next time it is placed on the Orbit.

Note:

One Orbit can only pair with one Lunar at the same time. If you want to pair with another Lunar, please reset the pairing in the App, or reset the Orbit to factory default.

Weight-Based Grinding

- Click
- Double Click
- Press and Hold

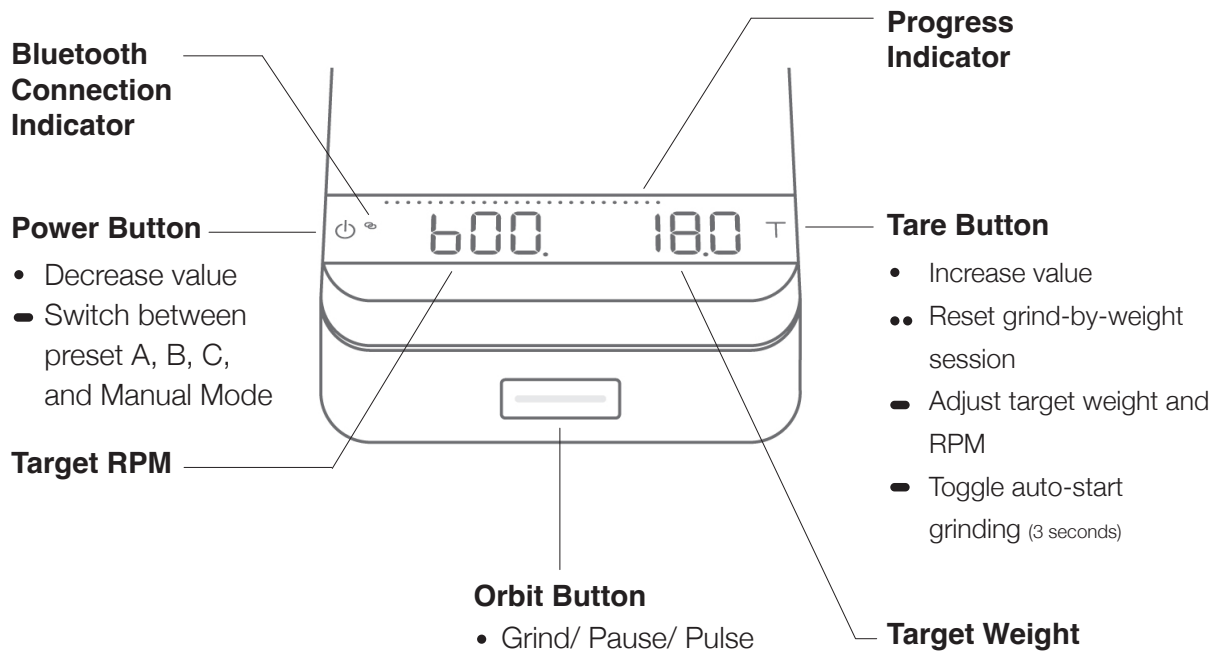

Adjusting Weight and RPM in Grind-by-weight Mode

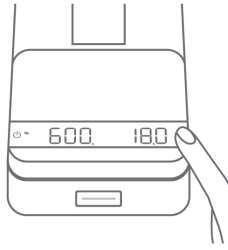

- 1** To adjust the target weight and RPM, **press and hold** T until the weight starts blinking.

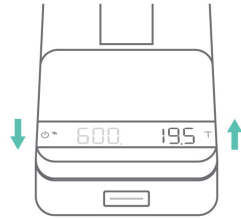

- 2** When the weight starts blinking, **tap** T to increase and **tap** ⏻ to decrease.

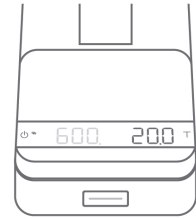

- 3** When you reach the desired target weight, **wait 5 seconds** to move on to the RPM adjustment.

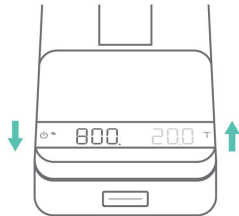

- 4** When the RPM starts blinking, **tap** T to increase and **tap** ⏻ to decrease.

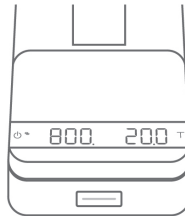

- 5** When you reach the desired RPM, **wait 5 seconds** to save.

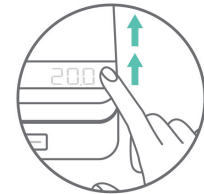

- 6** When adjusting target weight and RPM, **press and hold** T / ⏻ to speed up the adjustment.



- 7** Make sure to **remove** the spout extender from the Orbit spout and **place** the dosing cup on the Lunar.

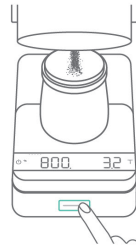

- 8** To begin the grinding session, **click** the Orbit button. The Orbit will start grinding until the target weight is reached.



- 9** When the target weight is reached, the Orbit will automatically stop the motor.

Note: In Grind-By-Weight mode, when the grinder detects no coffee in the chute, it automatically stops after 60 seconds.

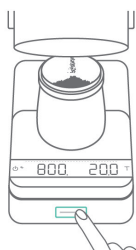

- 10** At the end of each session, you can click the Orbit button to pulse a small amount of coffee if needed.



- 11** **Remove** the dosing cup or **double tap** T to reset the current grind-by-weight session.

Product Care Information

Care and Maintenance

- **Do not** immerse the Orbit in water. Use a soft cloth with warm water only to clean the product.
- **Do not** use detergent or other chemicals for cleaning as this can damage the product.
- **Do not** perform burr cleaning or burr replacement without proper knowledge or technique. Acaia is not responsible for realignment or reassembly of the grinder once it is disassembled.
- **Minimizing Oxidation:** Store your grinder in a dry, low-humidity environment when not in use to reduce oxidation.
- **Preserving Flavor Quality:** If you detect a metallic taste, grind a small amount of coffee beans and discard them to refresh the burrs and remove any oxidation.

To maintain a low retention for the Orbit, we recommend cleaning the spout regularly in the steps below:

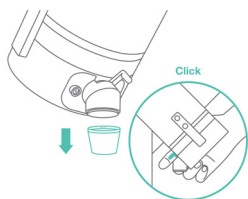

1. **Remove** the spout extender and **use the knocker** multiple times.

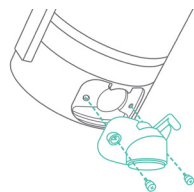

2. Using a small cross slot screwdriver, **remove** the two screws from the Orbit spout on the burr housing.

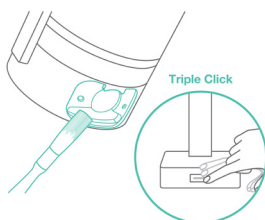

3. **Remove** the spout. **Clean** the Orbit spout with a brush and activate purge by **triple clicking** the Orbit button.

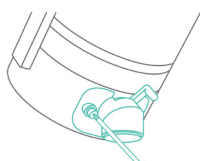

4. **Reassemble** the Orbit spout with the burr housing and fasten with two screws. These screws can be replaced with thumb screws for easy assembly.

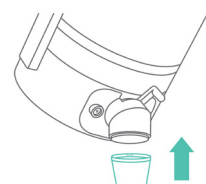

5. **Attach** the spout extender.

Appendix

Troubleshooting

The Orbit button will turn **Red**  and stop grinding when the motor encounters an issue. The following are some instructions for basic troubleshooting:

1. Turn off the main power and adjust the dial towards a coarser grind. Try restarting the grinder.
2. If step 1 does not fix the issue, please follow our cleaning steps and clean the Orbit thoroughly. Make sure there are no foreign substances in the bean chamber before restarting the grinder.
3. If the Red light persists, please contact our customer support service for further assistance.

Burr Rusting on Orbit Grinder

It is normal to observe slight rusting on the burrs of your Orbit grinder. Each Orbit unit undergoes a rigorous quality assurance process before leaving our facility, including grinding coffee for particle analysis. Due to this testing process as well as varying environmental conditions during transit, this may result in minor surface rusting or discoloration of the burrs.

This rust is harmless to health, though it may subtly affect coffee flavor. For the best initial experience, we recommend grinding 3–5 grams of coffee beans before first use to remove any light rust and restore the burrs to optimal condition.

Frequently Asked Questions

Q1: What is the “seasoning” of burrs, and why is it important?

A: The seasoning of burrs is a process that occurs over time as the burrs grind coffee. After a certain period, the grind particles become more consistent, which contributes to a better brewing result. The amount of time it takes for burrs to become seasoned can vary based on different factors such as usage and the type of beans being used.

Q2: Can I adjust the touch point to 0 on the dial?

A: No, it's not possible to match the touch point to 0 on the dial because each grinder is built to match the specific burr set it is using. However, we have designed the detent ring to help users mark their own zero point or touch point for future reference.

Q3: Does the dosing cup magnet affect scale readings?

A: The dosing cup magnet can affect the readings, but this does not impact the weighing after you perform a tare. The weight result will remain accurate and consistent.

Q4: What could be causing a rubbing sound in my grinder?

A: The rubbing sound could be caused by particles stuck between the burrs or by the burrs touching each other at very fine settings.

Q5: What could cause a “chirping sound” from the grinder besides the burr “touching point”?

A: The chirping sound could be due to particles from previous grind sessions. You can try running the grinder and rotating the dial slightly past the marked touch point, then back to coarser grind settings.

Q6: Is it normal for the Orbit to have a delay when starting?

A: Yes, the Orbit takes about 1-2 seconds to wake up after being on standby for a long period of time. We are working on improving this user experience.

Q7: What if grinds are coming out of the adjustment dial?

A: In the long run, there might be some grinds coming out rarely, but this is unavoidable. When this happens, clean the dial ring by opening up the front cap, and it will resolve the issue.

Q8: How does the Orbit perform in terms of retention?



A: The Orbit is designed as a low retention grinder, usually with less than 0.1 grams of retention from dose to dose. We have made adjustments and improvements to the knocker, breaker, and dosing cup pad to ensure consistent removal of retention.

Reset to Default

To reset the Orbit to factory default, **press and hold** the Orbit button in the front while the Orbit is in standby mode. **Hold for about 10 seconds** and **release** the Orbit button when the button turns Green . Once released, the Orbit will be reset to factory default.

You can also reset the Orbit to factory default with the Orbit APP.

Enter the Orbit Firmware Update Mode

To enter the Orbit firmware update mode, **press and hold** the Orbit button in the front while the Orbit is in standby mode. **Hold for about 15 seconds** and **release** the Orbit button when the button turns from Green  to Red . Once released, the Orbit will enter firmware update mode.

Specifications

Model	AOT007 Acaia Orbit Coffee Grinder - White (Mazzer 0033M) AOT008 Acaia Orbit Coffee Grinder - White (SSP Multi-Purpose) AOT009 Acaia Orbit Coffee Grinder - Black (Mazzer 0033M) AOT010 Acaia Orbit Coffee Grinder - Black (SSP Multi-Purpose) AOT011 Acaia Orbit Coffee Grinder - Space Gray (Mazzer 0033M) AOT012 Acaia Orbit Coffee Grinder - Space Gray (SSP Multi-Purpose) AOT013 Acaia Orbit Coffee Grinder - Space Gray (SSP Lab Sweet V3)
Product Weight	6130 g ± 10 g
Product Dimensions	W: 108 mm L: 266 mm H: 394 mm
Rated Voltage	100V-240V
Frequency	50/60Hz
Motor	200W Brushless DC Motor
Material	Aluminum, PC, Stainless Steel
Operating Ambient Temperature	0 - 40 °C
RPM Profile	600-1500 Adjustable RPM Profile
Duty Cycle	Recommended duty cycle for Orbit is 60s running time with a rest time of 30s
Connectivity	Bluetooth 5.0
Inside the Package	Acaia Orbit Coffee Grinder x 1 Power Cable x 1 58 mm Portafilter Dosing Cup (M) with Magnetic Pad x 1 Lunar Magnetic Strips Application Tool x 1 Accessory Tool Kit x 1

Copyright

This user manual is protected by copyright. All rights reserved. No part of this manual may be reproduced, processed, duplicated or published in any form by photocopying, microfilming, reprinting or any other method, in particular electronic means, without the written consent of Acaia.

© Acaia, California, 2024.