

acaia



**Acaia Orion Nano
User Manual**

AON301

Contents

3	Introduction
3	Features
4	Unpacking your Orion Nano
4	Orion Nano Overview
5	Interface Overview
5	Interface Overview
5	LED Indicators
6	Setting Up the Orion Nano
7	Getting Started
9	Product Care Information
9	Charging your Orion Nano
9	Care and Cleaning
10	Mode Introduction
10	Mode 1 - Manual Dosing Mode
11	Mode 2 - Auto Dosing Mode
12	Mode 3 - Weighing Mode
13	Mode 4 - Belt Mode
16	Configuration
16	Accessing the Orion's Settings
16	Diagram of the Settings Menu
19	Appendix
19	Buttons
20	Firmware Update
21	Error Codes
21	Other
22	Specifications

Introduction

Welcome to your new Acaia Orion Nano.

Designed for achieving precise and customizable coffee bean dosing. The Orion Nano is ideal for cupping sessions and seamless on-demand dosing in cafes. Achieve effortless coffee blending through its innovative connectivity feature, Orion's Belt.

Features

The Orion Bean Doser™ is designed for dosing green beans or roasted coffee beans based on weight.

Accuracy

The Orion Nano is capable of dosing accurately within ± 0.25 g (around 1 to 3 beans). It is the best tool for cupping or single-dose preparation, ensuring a consistent brew every time.

Footprint

The Orion Nano boasts a much more compact footprint, making it the perfect addition to any coffee bar or home brewing setup.

Orion's Belt

Form your own dynamic coffee blending station. The Orion's Belt integration connects multiple Orion Nanos. This innovative feature enables effortless customization of blends, giving you the space to experiment with ratios and flavors. Elevate the art of coffee crafting.

Technology

The Orion Nano inherits much of the Orion's award-winning design. Features include an automatic mode for continuous dosing and an intuitive dial interface with preset modes for diverse target weights. The intelligent dosing system learns and adapts for exceptional accuracy and consistency.

Unpacking your Orion Nano



Acaia Orion Nano



Type-C Charging Cable



Universal Power Adapter

Orion Nano Overview

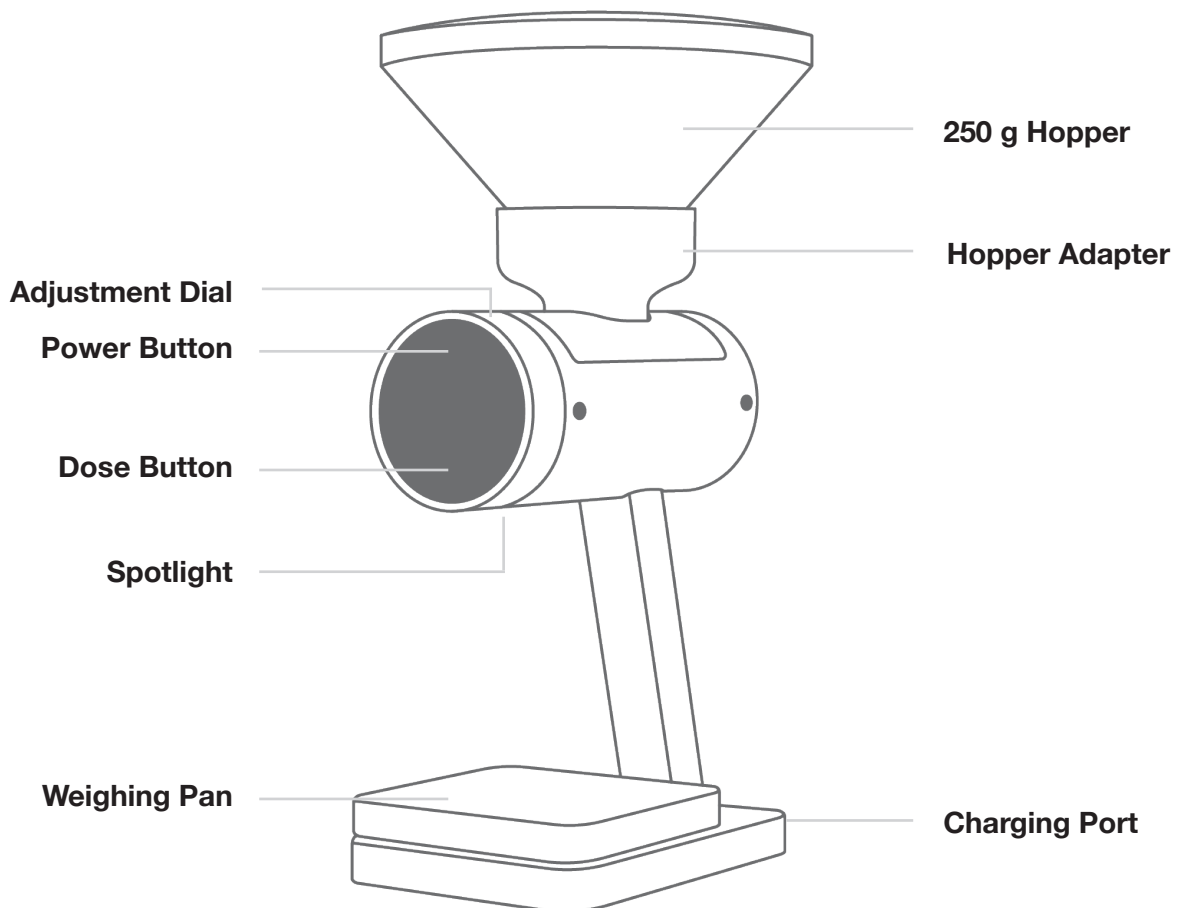

Interface Overview

Interface Overview

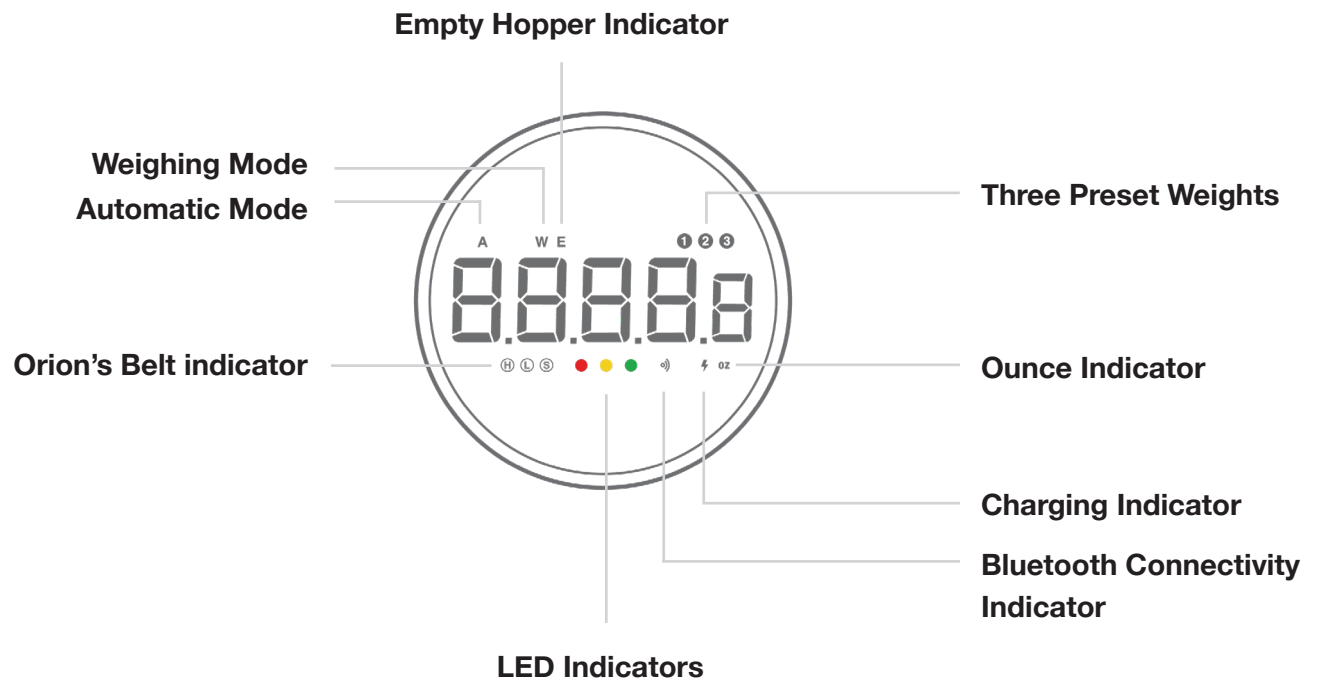

LED Indicators

- **Green Light - Dosing progress indicator**

When the green light is blinking, dosing is in progress. Once dosing is complete, the indicator will display a solid green light.

- **Yellow Light - Dose warning indicator**

When the yellow light is lit, it means that the current dose is at least 0.5 grams less or more than the target amount. You may want to add some beans with the pulse function or remove some.

- **Red Light - System message indicator**

When the red light is displayed, there is a system error with the Orion Nano. Restart the Orion Nano. If the problem persists, please contact us at support@acaia.co.

Setting Up the Orion Nano

Initial Setup

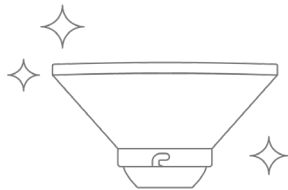

- 1** Rinse and clean the bean hopper with warm soapy water before your first use. Dry immediately after cleaning.

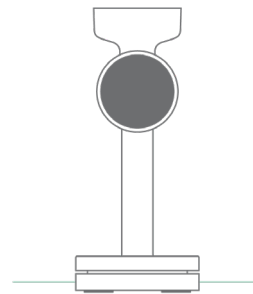

- 2** Place your Orion Nano on a flat, stable surface.

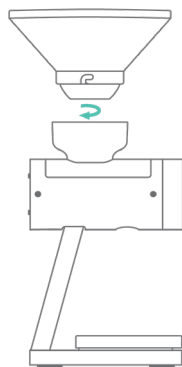

- 3** Attach the Orion Nano hopper on the hopper adapter.

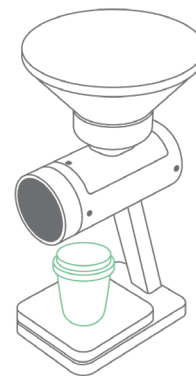

- 4** Before dosing, make sure to position a dosing cup or container beneath the chute to catch any beans that might fall when adding them into the hopper. You will see a spotlight showing the best spot to place your cup when you turn on the Orion Nano.

Getting Started

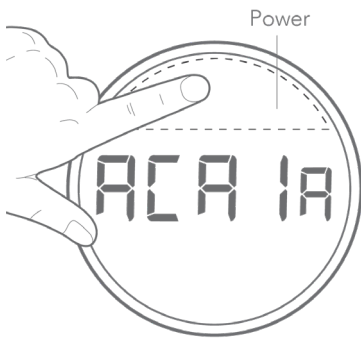

Power On/Off

[Press] **Power** to turn on device.
[Double press] **Power** to turn off device.



Start Dosing

[Press] **Dose** to start dosing, and press again to stop if you want to end before the session is complete.

Pulse

At the end of dosing, you may [press] **Dose** several times to pulse and add a few beans if needed.

Empty Hoper

[Press and hold] **Dose** to empty the hopper. An 'E' indicator will appear in the upper left corner of the display. [Press] **Dose** again to stop.

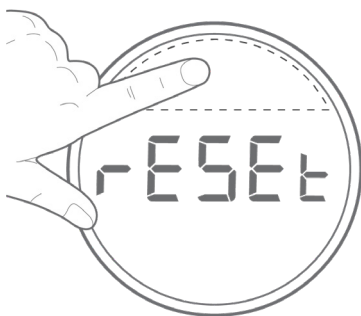

Cup Reset

[CUP] [rESEt] will appear on the display if no container is detected on the platform. You can dismiss the warning by pressing **Power**, and it will not appear again until the Orion Nano is restarted.

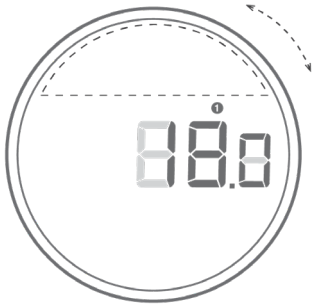

Dial Interface / Adjust Weight

[Rotate] the dial to toggle between different preset weights. [Press] **Power** and the preset starts flashing. Turn the Dial to adjust the preset weight and [press] **Power** again to save your setting.



Toggle Modes

Switch between modes [Press and hold] **Power** to see the current mode. [Rotate] the Dial to switch between Manual and Auto modes. [Press] **Power** again to save your setting.



Auto Dosing Mode

[Press and hold] **Power** for 3 seconds to enter mode settings. Turn the Dial to select "Auto" and [press] **Power** to save your setting. [Press] **Dose** to enter Ready mode. You can then begin auto-tare and auto-dosing.

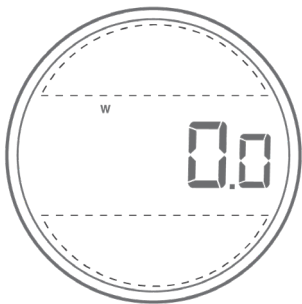

Weighing Only Mode

In weighing mode, the Orion Nano functions as a scale with a 500 g capacity. Place the object on the platform and the weight will show on the display. The **Power** and **Dose** buttons will function as 'Zero' and 'Tare'.

Product Care Information

Charing your Orion Nano

When the Orion Nano shows “Low Bat”, please charge the Orion Nano with the type-C charger included in the package. The Charging indicator will display when the battery is charging and will turn off when the Orion Nano is fully charged.

The Orion Nano can be used without a charging cable. You may want to fully charge it before your first use. The battery lasts for about 12 hours when fully charged.

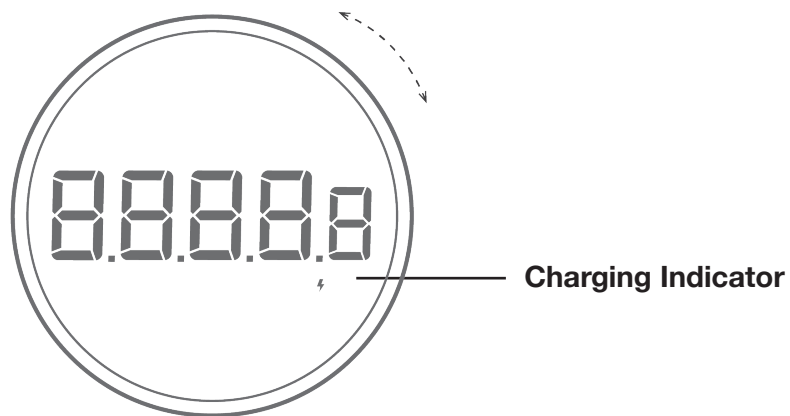

Care and Cleaning

- Use a soft cloth with warm water to clean the product only.
- Do not use detergent or other chemicals for cleaning as it can damage the anodized coating on the product.

Mode Introduction

Mode 1 - Manual Dosing Mode



This is the default dosing mode. The Orion Nano allows you to store three presets for your desired weights. For instance, you can set preset 1 to 10g, preset 2 to 20g, and preset 3 to 30g. The minimum weight for the preset is 4g.

Action	Operation
Start / Stop Dosing	Press Dose
Pulse Beans	Press Dose
Reset Mode	Press Power

1. Select a preset by rotating the Dial. Adjust the preset value by pressing **Power** and rotating the **Dial**. Press **Power** to confirm.
2. Press **Dose**, and the Orion Nano will begin dosing until the desired weight is reached within ± 0.25 g (A solid green LED will display to indicate an accurate dose).
3. At the end of dosing, you may press **Dose** several times to 'pulse'. Pulse will slowly add a few more beans if needed.
4. Press Power to reset and return to Dosing mode.
 - Manual dosing mode can dose on demand with a selected preset.
 - [CUP] [rESEt] will appear on the display if no container is detected on the platform. You can dismiss the warning by pressing Power, and it will not appear again until the Orion Nano is restarted.
 - A [NOISE] message will appear if a container is removed from the Orion Nano or if the platform is touched during dosing. Please dose again.

Pulse in Manual Dosing Mode

The Orion Nano has a pulse function that adds a few beans to the dose manually at the end of each dose. To pulse (add) a few more beans at the end of each dose, simply press the **Dose** and the Orion Nano will dispense add a small amount of beans with each press. If one press doesn't drop any beans, you can press it multiple times until the desired weight is reached.

Mode 2 - Auto Dosing Mode



Auto dosing mode dispenses coffee whenever a container is placed on the platform. When in Auto mode, you will see an 'A' indicator in the top left corner of the display. Press **Dose** and a [rEADY] message will appear on the display. To exit the [rEADY] display, press **Power** to return to the preset weight.

Action	Operation
Start / Stop Dosing	Press Dose
Pulse Beans	Press Dose
Reset Mode	Press Power

Display	Description
rEADY	Place container on the platform; dosing will start when weight is detected

1. Switch into automatic dosing mode by pressing and holding **Power** and selecting the Auto mode with the Dial. Press **Power** again to confirm the mode.
2. Select or adjust a preset weight.
3. Press **Dose** to start automatic dosing, the display will show [rEADY].
4. To start the first dose, press **Dose** again and the automatic dosing will begin.
5. Remove the completed dose, and wait for the display to show [rEADY] again.
6. Place another container on the platform and dispensing will start again.
7. Press **Power** to set a different dose and leave the current auto dosing session.

- In Auto dosing mode, the Orion Nano will dose automatically when a container is placed on the platform.
- There will be an 'A' indicator in the top left corner of the display when in Auto mode.
- [CUP] [rESEt] will appear on the display if no container is detected on the platform. You can dismiss the warning by pressing **Power**, and it will not appear again until the Orion Nano is restarted.
- A [NOISE] message will show when a container is removed from the Orion Nano or the platform is touched during dosing. Please dose again.

Pulse in Auto Dosing Mode

The Orion Nano has a pulse function that adds a few beans to the dose manually at the end of each dose. To pulse (add) a few more beans at the end of each dose, simply press the **Dose** button and the Orion Nano will dispense add a small amount of beans with each press. If one press doesn't drop any beans, you can press it multiple times until the desired weight is reached.

Mode 3 - Weighing Mode

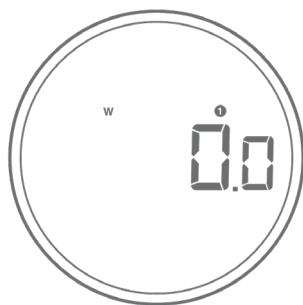

The weighing mode is the Orion Nano's smart scale mode, functioning as an industrial weighing scale with a 500-gram capacity.

Action	Operation
Reset Mode/Zero	Press Power
Tare	Press Dose

1. To enter the weighing mode, rotate the Dial until a 'W' indicator appears in the top left corner of the display.
2. Place the object you wish to weigh on the platform and the weight of the object will show on the display.
3. The Power and Dose buttons will function as 'Zero' and 'Tare'.

There are two different weighing units in Weighing Only Mode: grams and ounces.

- The LED display shows [0.0] when the scale is measuring in grams.
- The LED display shows [0.000] when the scale is measuring in ounces.
- The readability is 0.1 g for grams and 0.004 oz for ounces.

Mode 4 - Belt Mode

Orion's Belt Connection

With the Orion Nano, you can craft your custom coffee blend with exceptional precision. Connect up to 3 Orion Nanos to create an on-demand coffee-blending station.

Our Orion's Belt innovative feature represents our latest development, and we are dedicated to ongoing improvements. We highly recommend you regularly check for the latest firmware updates here to ensure this function operates at its best.

Note:

1. When establishing connection for 3 Orion Nanos, please pair using [PAir 1][PAir 2] first, followed by [PAir 1] and [PAir 3] .
2. If you wish to pair only 2 Orion Nanos, please pair using [PAir 1] and [PAir 3] .
3. In Orion's Belt mode, the Sleep (Power Saver) function will be disabled.

Follow the instructions below to set up the Orion's Belt:

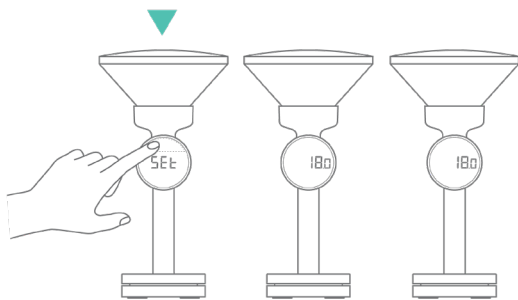

- 1** With Orion Nano powered on, press and hold Power to enter the Setting mode. [SEt] will appear on the display.



- 2** Press Dose to access the Settings Menu. The first setting [SPEEd] will be displayed.



- 3** Rotate the dial until [bELt] is shown, then press Dose.

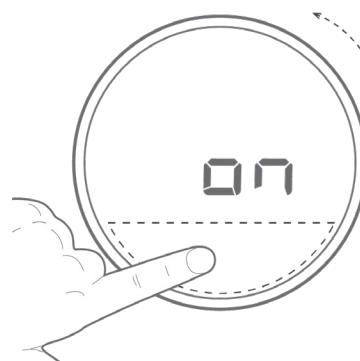

- 4** Rotate the dial to switch the connection to "on", and press Dose again to save the settings.



5 Rotate the dial to display [bELt.p], then press Dose, it will be display [1].



6 Press Dose again to show [PAir 1]. This unit will serve as the master unit.

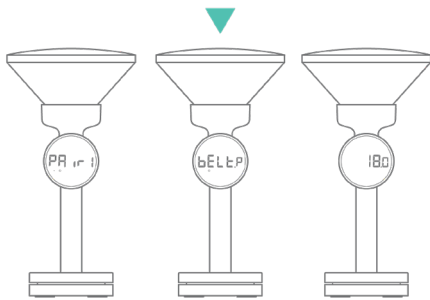

7 Repeat steps 3 to 4 on the second unit you wish to pair.

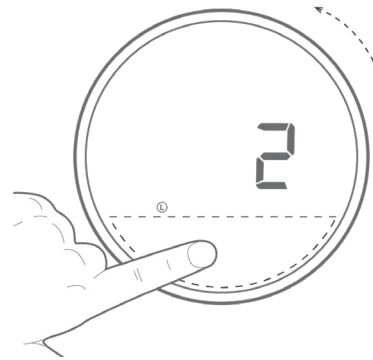

8 Select [2] in [bELt.p] setting, press Dose to confirm.



9 [PAir 2] will be displayed.

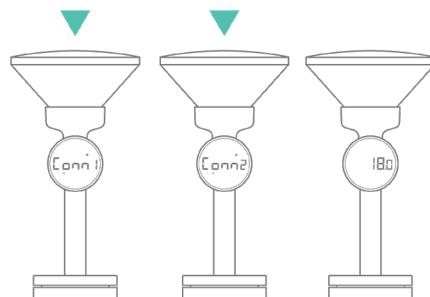

10 Pairing starts automatically. [Conn 1][Conn 2] will prompt once the connection is established and then return to dosing mode. The link indicator will stop flashing.

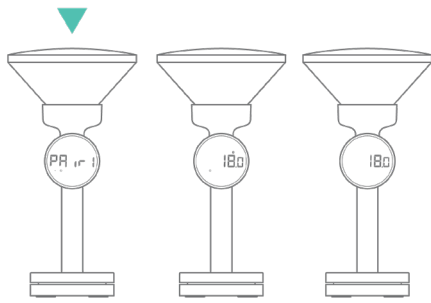

- 11** Go back to the first unit and enter the [bELt] mode. Rotate the dial to select [1] in [bELt.p] setting, press Dose. [PAir 1] will be displayed.

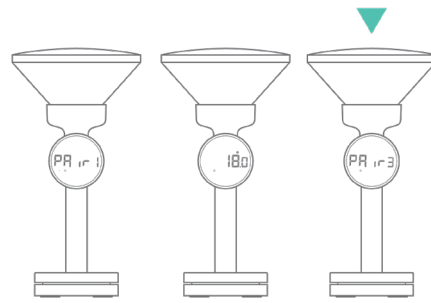

- 12** Repeat steps 3 to 4 on the third unit you wish to pair, rotate the dial to select [3] in [bELt.p] setting, press Dose to confirm. [PAir 3] will be displayed.

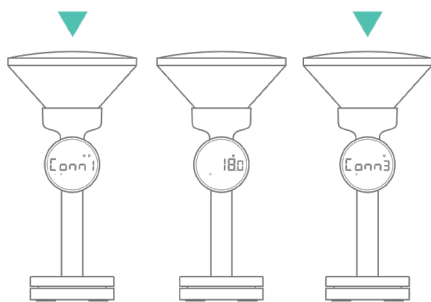

- 13** Pairing starts automatically. [Conn 1][Conn 3] will prompt once the connection is established and then return to dosing mode. The link indicator will stop flashing.

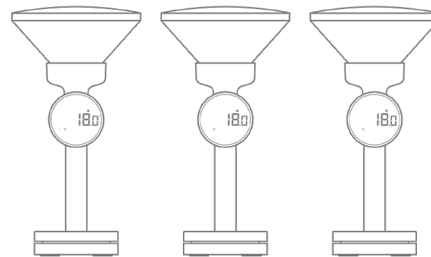

- 14** The indicator [L] will remain lit on all units when they are connected and a [.] icon will be shown on the master unit.

Configuration

Accessing the Orion Nano's Settings

1. With Orion Nano powered on, press and hold **Power** to enter the Settings mode. The display will show [SEt].
2. Press **Dose** to enter the Settings Menu. It will show the first setting for [SPEEd].

Action	Operation
Enter Setting Mode	Press and hold Power
Enter Setting Menu	Press Dose

Diagram of the Settings Menu

Setting	Display	Options	Default
Speed	SPEEd	FASt, PrEC, grEEEn	PrEC
Sleep Timer	SLEEp	5, 15, 30, Off	5
Zero Tracking	trAcE	05, 1 d, 2 d, 3 d, 4 d, 5 d, OFF	1 d
Key Sound	bEEP	On, Off	On
Default Weighing Unit	Unit	g, oZ	g
Cup Detection	CUP.d	On, OFF	On
Orion's Belt Connection	bELT	On, Off	Off
Belt Setting	bELT.P	1,2,3	1
Calibration	CAL	(Perform a smart calibration)	-
About	About	(Shows the current Orion Nano firmware version)	-

Dosing Speed [SPEEd]

You may adjust the dosing speed to prioritize either the accuracy or the speed of dosing. There are three speed settings available:

1. PrEC — Precision: Default speed, high accuracy. (default)
2. FASt — Fast: Faster speed, default accuracy (227 grams within 12 seconds); recommended for doses of 100 grams or more.
3. GrEEEn — Green Bean: Default speed for green beans or light roast beans.

To save your selection and exit the settings sub-menu, press **Dose**. [SPEEd] will display on the LED to confirm that the selected option has been saved.

Sleep Timer Setting [SLEEP]

The number indicates the amount of time before the Orion Nano automatically powers off. For example, when 5 is selected, the Orion Nano powers off after 5 minutes of being idle if the Orion Nano is disconnected from all mobile devices.

Zero Tracking Setting [trAcE]

Zero Tracking is a function to help compensate the weight readout fluctuations at zero point to improve the usability of the scale. The Acaia Orion Nano is allowed to compensate fluctuations by up to 2d according to industrial weighing guidelines.

1. Off: It is not recommended to turn off Zero Tracking; the zero indication can drift easily as the room temperature changes.
2. 0.5 d~5 d: For example, since each division is 0.1 g, 5 d = 0.5 g. When Zero Tracking is set to be 5 d, any initial weight between +/- 0.5 g on the weighing pan will be zeroed out.
3. 1 d is recommended in general for the Orion Nano.

To save your selection and exit the settings sub-menu, press **Dose**. [trAcE] will display on the LED to confirm that the selected option has been saved.

Key Sound Setting [bEEP]

1. Set the Key Sound function to Off/On to turn off/turn on the beeping sound.

To save your selection and exit the settings sub-menu, press **Dose**. [bEEP] will display on the LED to confirm that the selected option has been saved.

Default Weighing Unit [Unit]

1. The Default Weighing Unit is set to grams if [9] is selected and ounce if [o2] is selected.
2. Rotate **Dial** to switch the Default Weighing Unit between grams and ounces.

To save your selection and exit the settings sub-menu, press **Dose**. [Unit] will display on the LED to confirm that the selected option has been saved.

Cup Detection [CUP.d]

1. The default setting is on.
2. On: Cup detection enabled. Orion Nano will check if there is a container on the weighing platform. If no container is detected, Orion Nano will not start dispensing the coffee beans.
3. Off: Cup detection is disabled. Orion Nano will start dispensing the coffee beans even if no container is detected.

Orion's Belt Connection [bELT]

1. The default setting is Off.
2. On: Orion's Belt function is enabled.
3. Off: Orion's Belt function is disabled.

Belt Setting [bELT.P]

You may set the Orion Nano as the master unit or subordinating unit when establishing a connection. Select [1] to set the Orion Nano as the master unit. Select [2] or [3] to set the Orion Nano as the secondary unit.

Calibration [CAL]

The Orion Nano is a precision instrument, and regular calibration is recommended for frequent use. Before performing a smart calibration, select Weighing Mode and ensure the weighing unit is in grams, and follow the steps below:

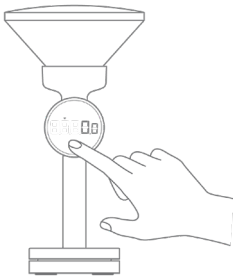

- 1** Press the Dose rapidly 5 times in the weighing mode to enter the user calibration mode.



- 2** While LED display shows [CAL] and then [100]. Place a 100 g calibration weight and wait for the scale to execute the calibration procedure.



- 3** The Display shows [-End-] when the calibration procedure is completed.

Note: You may use a 100 g or 500 g weight for calibration. To ensure accuracy, use Acaia calibration weights or F1 or F2 Class calibration weights.

About [About]

Shows the current Orion Nano Firmware version.

To update to the latest version, please refer to "Updating the Orion Nano's Firmware"

Appendix

Buttons

Button	Example
Power Button	Press to turn on the Orion Nano
	Double press to turn off the Orion Nano
	Press to set/save preset weight
	Press and hold to switch to Manual/Auto Mode
	Press to save the Setting and go back to Menu
Dose Button	Press to start dosing when in Manual/Auto mode
	Press and hold for 5 seconds to empty the hopper
	Press to stop emptying the hopper
	Press to save the Setting and go back to Menu
Rotate Dial	Rotate to toggle presets/modes
	Rotate to adjust the preset weights

Updating the Orion Nano's Firmware

Use the Acaia Updater app to learn about the latest firmware releases and updates for the Orion Nano. To update the firmware, please do the following:



1 Use the Acaia Updater app to learn about the latest firmware releases and updates for the Orion Nano.

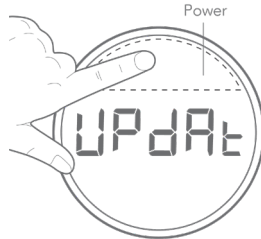

2 When the Orion Nano is powered off, press and hold Power until [UPdAt] is displayed.

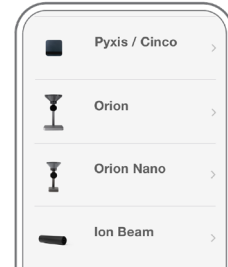

3 In the Acaia Updater app, select Orion Nano. The app will download the latest available firmware. Select Next once complete.

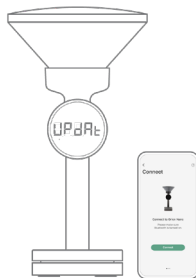

4 Place your phone close to your Orion Nano and tap connect.

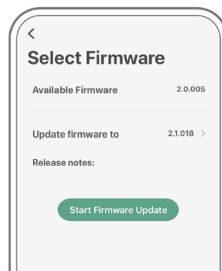

5 Your app will let you know your current firmware and prompt you to tap Next.

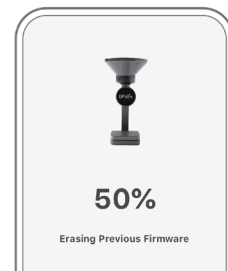

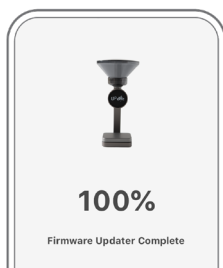

6 Tap Connect to connect the Updater to your Orion Nano. Your app will begin the firmware transfer and your product will enter update mode. (Don't turn it off!)



7 Once your firmware update is complete, your screen will display a Done button. Now you're all set to get back to brewing!

Error Codes

Error Code	Description
Error 100	Code error
Error 101	EEPROM error
Error 102	AD read error
Error 303	Unable to make zero point because the initial weight exceeds the limit (250% of capacity).
	Overload: The weight is over the maximum capacity.
	Underload: The weight is under the minimum capacity.
Error 304	Please calibrate the Doser in a stable environment free of vibration, wind, etc.
Error 802	Unable to tare because the weight exceeds the tare range.
Error 803	Unable to tare due to unstable weight.
Error 904	Password error (the default password is 0000).

Other

Display Code	Description
UPdAtE	The Orion Nano is in Update mode. Note: The Orion Nano will automatically turn off and exit update mode after 90 seconds of inactivity.

Specifications

Model	AON 301
Color	Space Gray
Product Weight	1370 g ± 5 g
Product Dimensions	W: 163 mm L: 174 mm H: 314 mm
Maximum Capacity	500 g / 17.63 oz
Minimum Weight	0.1 g
Measuring Units	g / oz
Readability	0.1 g
Repeatability	0.1 g
Linearity	1d
Indication Limit	515 g / 18.16 oz
Power Supply	5V / 3A
Battery	Lithium-ion rechargeable 7.4 V 2200 mAh
Battery Life	Up to 12 hours when fully charged
Display	LED
Material	Aluminum, PC, Stainless Steel
Connectivity	Bluetooth 5.0
Warranty	1 Year
Inside the Package	Acaia Orion Nano Bean Doser x 1 250 g Hopper x 1 Type-C charging cable x 1 Universal Power Adapter x1

Copyright

This User Manual is protected by copyright. All rights reserved. No part of the manual may be reproduced, processed, duplicated or published in any form by photocopying, microfilming, reprinting or any other method, in particular electronic means, without the written agreement of Acaia.

© Acaia, California, 2023.